

formül®



2021-1 FİYAT LİSTESİ



Formül; plastik sektöründeki ihtiyaçları karşılamak amaçlı üretim serüvenine, kurulduğu 1990'lı yılların başında bir **plastik kalıp atölyesi** olarak başlamıştır.

2000 yılında PP-R boru ve ek parçaları üretimine başlamıştır.

Yıllar içerisinde tecrübe kazanan firmamız çok gözlü kalıpları kendi bünyesinde yapan **tek firma** olmanın avantajıyla, PP-R boru ve ek parçalarında sektörde **en geniş ürün yelpazesine** sahip firma olmuştur.

Son yıllarda **Veliköy ve Çerkezköy** Organize Sanayi Bölgelerinde tamamen **Avrupa standartlarına uygun** modern fabrika binaları kurmuş ve makinelerini yenilemiştir. Montaj, ambalajlama, paketlenme ve kolileme çalışmaları otomatik makinelerde gerçekleştirilmektedir.

Formül; vanalar ve tüm metalli ek parçaların **metal aksamlarını** Çerkezköy'de bulunan tam otomatik makinelerle üretim yapan kendi tesisinden karşılamaktadır. **Kendi metal ihtiyaçlarını üreten** ender firmalardan biridir.

Son yıllarda sektörün ihtiyaç duyduğu iki farklı ürün grubu olan **PE-RT boru** ve **PVC atık su ürün grubunu** bünyesine katmıştır.

Kalorifer tesisatları ve yerden ısıtma sistemlerinde güvenle kullanılan **PE-RT Borular**, sıcaklık direnci yükseltilmiş ısıya dayanıklı polietilenden üretilen, **son derece esnek ve kolay döşenen borulardır.**

PVC atık su boruları, 50 mm - 200 mm çap aralığında üretilip, **Avrupa kökenli** makinelerce muflanmakta ve contalı olarak kullanıma sunulmaktadır.





Dünya'nın tercihi,
Türkiye'nin markası



Kalite Yönetimi



Formül; mükemmel ürün kalitesi, geniş ürün yelpazesi ve yüksek üretim kapasitesiyle üst yapı tesisat sektöründe iddialı firmalardan biridir. Ürün yelpazesinin geniş olması firmamızı, müşterilerinin yanı sıra diğer PPRC üreticilerinin de ilgi odağı haline getirmiştir. Model firma özelliği ile plastik sektöründe saygın bir yer edinmiştir.

Dünyanın her bölgesine satış yapmak ve rekabet üstünlüğü sağlamak için ihtiyaç duyduğu uluslararası tüm kalite belgelerine, faydalı model ve patent belgelerine, ISO 9001-2015 kalite belgesi, ISO 27001-2013 Bilgi Güvenliği Yönetim Sistemi ve AEO Yetkilendirilmiş Yükümlü Sertifikası belgelerine sahip olmuş ve ürünlerinin uluslararası marka tescillerini yaptırmıştır. Bu belgeler arasında çok tanınmış olan TSE, DVGW, AENOR, CSTB, GOST, AVIZ TEHNIC, UKR SEPRO, SKZ, TZW ve diğer ülkelerin kalite sertifikaları; bağımsız kuruluşlar tarafından periyodik olarak denetlenmektedir. Bu belgelerle, müşterilerine yüksek kaliteli ürün, projeye özel uygulamalar ve çözümlerle başarılı organizasyonlar yapmayı garanti etmektedir.

Uluslararası geçerliliği olan AEO (Yetkilendirilmiş Yükümlü Sertifikası) belgesine sahip olan sektörümüzde ilk firma Formül'dür. Bakanlık tarafından güvenilirliğini kanıtlamış firmalara verilen AEO sayesinde Formül, ithal ettiği eşyayı direkt olarak fabrikasına alabiliyor ve ihraç ettiği ürünleri de fabrikadan direkt olarak gümrük sınırına gönderebiliyor.

Zamanla 5 kıtada 80'in üzerinde ülkeye ihracat yapar duruma gelen Formül, 2014'ten beri ülkemizin "İlk 1000 ihracatçı firması" arasında yer almaktadır.

Kısa sürede Afrika, BDT ülkeleri, Uzak Doğu, Orta Doğu ve Güney Amerika'da popüler ve istenilen bir marka haline gelmiştir.

Kaliteli ve mükemmel ürün üretme hedefiyle beraber, en öne müşteri memnuniyetini almış; laboratuvar çalışmaları ve AR-GE bölümünün desteği ile hatasız ürün üretme ilkesini benimsemiştir.

Eğitilmiş, nitelikli ve tecrübeli ekibimiz sizlere hizmet etmekten mutlu olmaktadır...

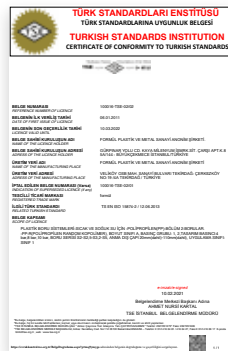
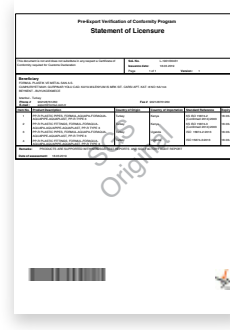

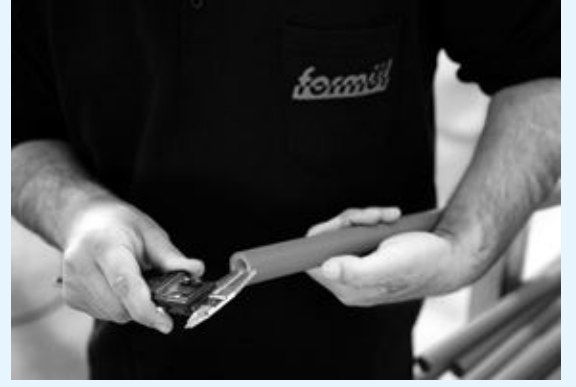

Notlar

- Fiyatlarımıza KDV dahil değildir.
- Fiyatlarımız fabrika teslim veya ambar teslim fiyatlarıdır.
- Firmamız haber vermeksizin fiyat değiştirme hakkına sahiptir.
- Lütfen siparişlerinizi faksla veya satis@formul.com.tr, satis-destek@formul.com.tr ve satis-operasyon@formul.com.tr adreslerine e-mail ile bildiriniz.
- Baskıdaki fiyat yazım hatalarından firmamız sorumlu değildir.





**Birinci
Kalite**

formül[®]



TEKNİK BİLGİ

1

Polypropylene Random Copolimer (PP-R)

Ham maddenin en önemli özelliği, ısıya ve kimyasal etkilere karşı gösterdiği yüksek dirençtir. Bu direnç sayesinde PP-R ham maddesinden markamız altında üretilen Boru ve Ek Parçaları, soğuk ve sıcak su tesisatlarında başarıyla kullanılmaktadır. PP-R ham maddesinin monomer yapısına sahip olması sayesinde, bünyesinde hiçbir biyolojik maddenin barınmasına izin vermez. PP-R ham maddesinden üretilmiş PP-R Boru ve Ek Parçalara renk, tat ve koku vermeyen üstün özellikler sağlar. PP-R ham maddesi içme suyu tesisatlarında, sıcak su, radyatör ve yerden ısıtma sistemlerinde ve birçok endüstriyel dağıtım sistemlerinde uzun ömürlü olarak kullanılır.

PP-R ham maddesi diğer plastıklere göre birçok avantaja sahiptir örneğin; uzun ömürlüdür, basınç ve sıcaklığa karşı yüksek dayanım gösterir, daha esnektir, yüksek ses ve ısı yalıtımına sahiptir, yüksek yoğunluktadır ve erime akış hızı düşüktür. PP-R ham maddesi ASTM F 2389, DIN 8077, DIN 8078, EN ISO 15874 Standartlarının gereksinimlerini karşılar.

PP-R Boru Avantajları

- 20°C'de 50 yıla kadar dayanım sağlayabilir.
- +95°C sıcaklığa kadar dayanır.
- Birçok kimyasal maddeye karşı yüksek dayanım gösterir.
- Aşınma ve korozyon direnci yüksektir, kireçlenme ya da paslanma yapmaz.
- Suyun rengini, kokusunu ve tadını değiştirmez.
- İç yüzeyi pürüzsüz ve kaygandır, bu sebeple sürtünme, aşınma direnci yüksektir.
- Kullanımda sırasında montaj edilmesi kolaydır.
- Montaj esnasında iş ve malzeme kaybına sebep olmaz.
- PP-R ham maddesinin üstün özellikleri sayesinde yüksek ses ve ısı yalıtımı sağlar.
- Zor alev alır.
- Geri dönüştürülebilir, çevre dostudur.

Teknik Özellikler

Özellikler		Birim	Test Metodu	Değerler
Yoğunluk	+23°C	g/cm ³	ISO 1183	0,909
Erime Akış İndeksi	190 °C /5 kg	g/10 dk	ISO 1133	0,4-0,6
	230°C /2,16 kg	g/10 dk	ISO 1133	0,2-0,5
	230°C /5 kg	g/10 dk	ISO 1133	0,8-1,3
Çekme Mukavemeti (23°C)	(50 mm/dk)	MPa	ISO 527	25
Çekmedeki Uzama	(50 mm/dk)	%	ISO 527	10
Elastiklik Modülü	+23°C	N/mm ²	ISO 527	800
Charpy Darbe Dayanımı (Çentikli)	+23°C	kJ/m ²	ISO 179	>15
	0°C	kJ/m ²	ISO 179	>5
Charpy Darbe Dayanımı (Çentiksiz)	0°C	kJ/m ²	ISO 179	Hasar Yok
Vicat Yumuşama Noktası	(1 kg)	°C	ASTM D 1525 ISO 306 DIN 53460	130
	(5 kg)	°C		60
Doğrusal Isıl Genleşme Katsayısı		1/K	DIN 53752	1,5x10 ⁻⁴
Isıl İletkenlik		W/mK	DIN 52612	0,24
Sertlik (Shore)	(3 sn değer)		ISO 868	65
Boru Sürtünme Katsayısı				0,007

PP-R'den Yapılan Ek Parçaların Mekanik Özellikleri (TS EN ISO 15874-3)

Özellikler	Gereklilik	PP-R İçin Yapılan Test Parametreleri					Test Metodu
İç basınca karşı gösterilen direnç	Test süresi boyunca hasar olmamalı	Hidrostatik Basınç (Mpa)	Test Sıcaklığı (C°)	Test Periyodu (h)	Test edilecek ürün adedi	Test basıncı (Bar)	ISO 1167-1 ISO 1167-3
		16,0	20	1	3	53,1	
		3,5	95	1000	3	11,6	

Boruların Mekanik Özellikleri (TS EN ISO 15874-2)

Özellikler	Gereklilik	PP-R İçin Yapılan Test Parametreleri					Test Metodu
İç basınca karşı gösterilen direnç	Test süresi boyunca hasar olmamalı	Hidrostatik basınç (Mpa)	Test sıcaklığı (C°)	Test Periyodu (h)	Test edilecek ürün adedi	Test Basıncı (Bar)	ISO 1167-1 ISO 1167-2
		16,0	20	1	3	64	
		4,3	95	22	3	17,2	
		3,8	95	165	3	15,2	
		3,5	95	1000	3	14	

Boruların Fiziksel ve Kimyasal Özellikleri (TS EN ISO 15874-2)

Özellikler	Gereklilik	Test parametreleri		Test Metodu
		Parametre	Değer	
Boyutsal kararlılık	≤ %2	Test sıcaklığı PP-R İlgili maruz kalma süresi: en ≤ 8 mm 8mm ≤ en ≤ 16mm en > 16mm Numune sayısı	135 °C 1 h 2 h 4 h 3	Method B of ISO 2505 (oven test)
Hidrostatik basınca karşı gösterilen termal kararlılık	Test süresi boyunca hasar olmamalı	Test sıcaklığı Hidrostatik basınç Test süresi Numune sayısı	110 °C 1,9 MPa 8760 h 1	ISO 1167-1 ISO 1167-2
Darbe dayanımı	≤ %10	Test sıcaklığı Numune sayısı	0 °C 10	ISO 9854-1 ISO 9854-2
Erime akış hızı (ham madde)	≤ 0,5g /10 dk	Test sıcaklığı Kütle Numune sayısı	230 °C 2,16 kg 3	ISO 1133-1
Erime akış hızı (boru)	Aynı partideki hamur ile karıştırıldığında maksimum %30 fark olmalı	Test sıcaklığı Kütle Numune sayısı	230 °C 2,16 kg 3	

Boru çapları ve toleranslar DIN 8077 standardına göre tablanmıştır.

SDR 11 (PN10)

Dış çap Ø mm.	Tolerans mm.	Et kalınlığı mm.	Tolerans mm.	İç çap Ø mm.	In" inches
20	+0.3/-0	1.9	+0.3/-0	16.20	1/2"
25	+0.3/-0	2.3	+0.4/-0	20.40	3/4"
32	+0.3/-0	2.9	+0.4/-0	26.20	1"
40	+0.4/-0	3.7	+0.5/-0	32.60	1 1/4"
50	+0.5/-0	4.6	+0.6/-0	40.80	1 1/2"
63	+0.6/-0	5.8	+0.7/-0	51.40	2"
75	+0.7/-0	6.8	+0.8/-0	61.40	2 1/2"
90	+0.9/-0	8.2	+1.0/-0	73.60	3"
110	+1.0/-0	10.0	+1.1/-0	90.00	4"
125	+1.2/-0	11.4	+1.3/-0	102.20	5"

SDR 7,4 (PN16)

Dış çap Ø mm.	Tolerans mm.	Et kalınlığı mm.	Tolerans mm.	İç çap Ø mm.	In" inches
20	+0.3/-0	2.8	+0.4/-0	14.00	1/2"
25	+0.3/-0	3.5	+0.5/-0	18.00	3/4"
32	+0.3/-0	4.4	+0.6/-0	23.20	1"
40	+0.4/-0	5.5	+0.7/-0	29.00	1 1/4"
50	+0.5/-0	6.9	+0.8/-0	36.20	1 1/2"
63	+0.6/-0	8.6	+1.0/-0	45.80	2"
75	+0.7/-0	10.3	+1.2/-0	54.40	2 1/2"
90	+0.9/-0	12.3	+1.4/-0	65.40	3"
110	+1.0/-0	15.1	+1.7/-0	79.80	4"
125	+1.2/-0	17.1	+1.9/-0	90.80	5"

SDR 6 (PN20)

Dış çap Ø mm.	Tolerans mm.	Et kalınlığı mm.	Tolerans mm.	İç çap Ø mm.	In" inches
20	+0.3/-0	3.4	+0.5/-0	13.20	1/2"
25	+0.3/-0	4.2	+0.6/-0	16.60	3/4"
32	+0.3/-0	5.4	+0.7/-0	21.20	1"
40	+0.4/-0	6.7	+0.8/-0	26.60	1 1/4"
50	+0.5/-0	8.3	+1.0/-0	33.40	1 1/2"
63	+0.6/-0	10.5	+1.2/-0	42.00	2"
75	+0.7/-0	12.5	+1.4/-0	50.00	2 1/2"
90	+0.9/-0	15.0	+1.7/-0	60.00	3"
110	+1.0/-0	18.3	+2.0/-0	73.40	4"
125	+1.2/-0	20.8	+2.2/-0	83.40	5"

Kullanım ömürleri DIN 8077 standardına göre belirlenmiştir. (SF=1,5)

Kullanım sıcaklığı (C°)	Kullanım ömrü	PN10	PN16	PN20
		Boru serisi (S)		
		5	3,2	2,5
		SDR		
		11	7,4	6
İzin verilen çalışma basıncı (Bar)				
10	1	17,5	27,8	35,1
	5	16,5	26,2	33,0
	10	16,1	25,6	32,2
	25	15,6	24,7	31,1
	50	15,2	24,1	30,3
20	1	15,0	23,7	29,9
	5	14,1	22,3	28,1
	10	13,7	21,7	27,4
	25	13,2	21,0	26,4
	50	12,9	20,4	25,7
30	1	12,7	20,2	25,4
	5	11,9	18,9	23,8
	10	11,6	18,4	23,2
	25	11,2	17,7	22,3
	50	10,9	17,2	21,7
40	1	10,8	17,1	21,6
	5	10,1	16,0	20,2
	10	9,8	15,5	19,6
	25	9,4	15,0	18,8
	50	9,2	14,5	18,3
50	1	9,1	14,5	18,2
	5	8,5	13,5	17,0
	10	8,2	13,1	16,5
	25	7,9	12,6	15,9
	50	7,7	12,2	15,4
60	1	7,7	12,2	15,4
	5	7,1	11,3	14,3
	10	6,9	11,0	13,9
	25	6,6	10,5	13,3
	50	6,4	10,2	12,9
70	1	6,5	10,3	12,9
	5	6,0	9,5	12,0
	10	5,8	9,2	11,6
	25	5,0	8,0	10,0
	50	4,2	6,7	8,5
80	1	5,4	8,6	10,8
	5	4,8	7,6	9,6
	10	4,0	6,4	8,1
	25	3,2	5,1	6,5
95	1	3,8	6,1	7,6
	5	2,6	4,1	5,2

PP-R Borularda Termal Genleşme

PP-R borular, metal borulardan çok daha yüksek bir genleşme katsayısına sahiptir. Bu nedenle, kurulum sırasında bu özellik dikkate alınmalıdır.

Termal genleşmenin hesaplanması aşağıdaki gibidir:

$$\Delta L = L * \Delta T * \alpha$$

ΔT = Ortam sıcaklığı ile su sıcaklığı arasındaki fark Kelvin derece (K) veya Santigrat (°C) cinsinden.

ΔL = Uzunluk değişimi (mm)

L = Borunun başlangıç uzunluğu (m)

α = Doğrusal termal genleşme katsayısı. PP-R boruları için α değeri $1,5 * 10^{-4}$ (K-1)'dir.

Standart PP-R Borunun Termal Genleşmesi

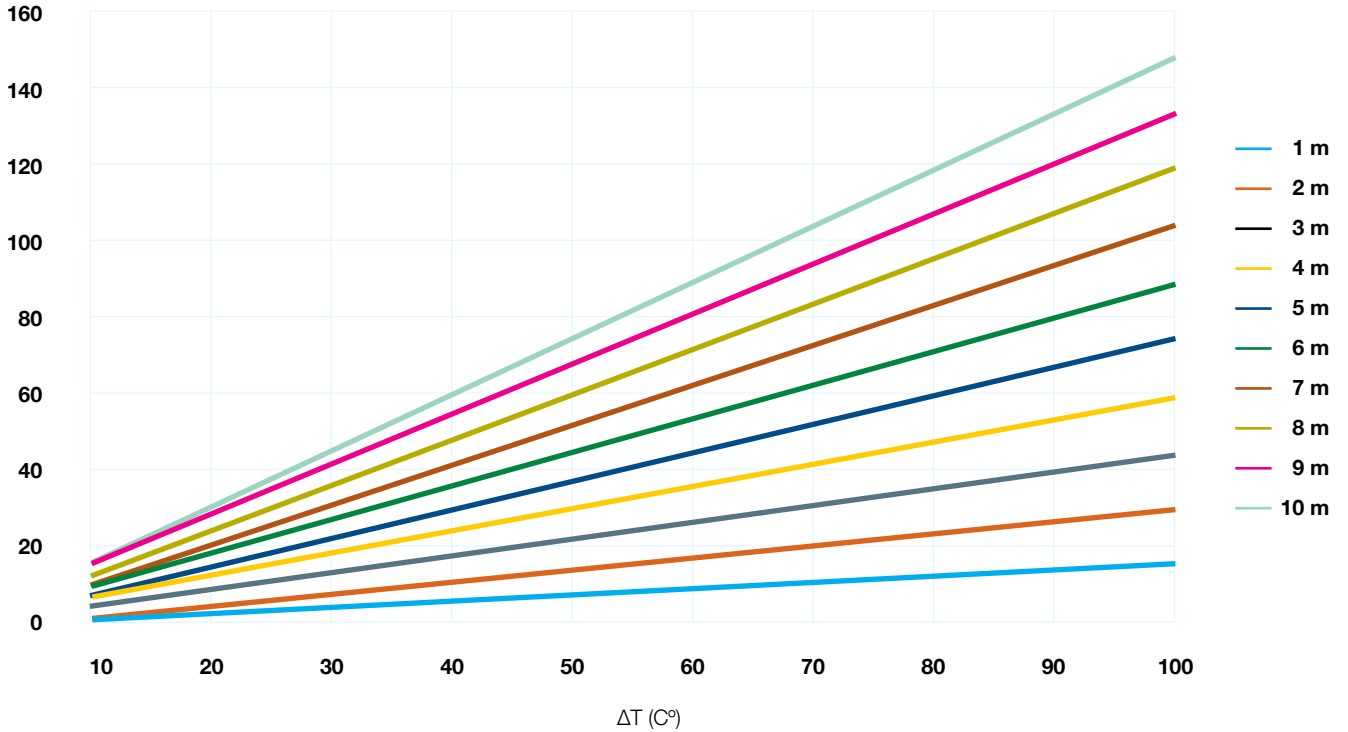

PP-R Cam Elyaf Takviyeli Boru

PP-R Cam Elyaf Takviyeli Boru (PP-R / GF / PP-R), iç ve dış katmanları PP-R'den ve orta katmanın özel PP-R ve cam elyaf karışımından oluşan 3 katman şeklinde üretilir.

PP-R Cam Elyaf Takviyeli Borunun Avantajları

1. Kaynak işleminden önce soyulmayı gerektirmediği için daha kolay ve daha hızlı kurulum sağlar.
2. Standart PP-R borudan% 75 daha az doğrusal genişleme özelliğine sahiptir.
3. Standart PP-R borudan daha yüksek sertliğe sahiptir.
4. Cam Elyaf PP-R borular, folyo borulara yakın termal genişleme katsayısına sahiptir, folyo boruların kullanıldığı alanlarda rahatlıkla kullanılabilir.

Genleşme katsayıları:

Cam Elyaf Takviyeli PP-R boru için: 0,035 mm / mK
Alüminyum Folyo Takviyeli PP-R Boru için: 0,030 mm / mK
Standart PP-R Boru için: 0,15 mm / mK

5. Standart PP-R borulardan daha hafiftir.

Kullanım Alanları

1. Her türlü sıcak ve soğuk su tesisatı
2. Pnömatik tesisatlar
3. Isıtma tesisatları ve radyatör bağlantıları.
4. Endüstriyel, sanayi sistemleri.

Cam Elyaf Takviyeli PP-R Boruda Termal Genleşme

Termal genişlemenin hesaplanması aşağıdaki gibidir:

$$\Delta L = L * \Delta T * \beta$$

ΔT = Ortam sıcaklığı ile su sıcaklığı arasındaki fark Kelvin derece (K) veya Santigrat (°C) cinsinden.

ΔL = Uzunluk değişimi (mm)

L = Borunun başlangıç uzunluğu (m)

β = Doğrusal termal genişleme katsayısı. Cam elyaf takviyeli PP-R boruları için β değeri $0,35 * 10^{-4}$ (K-1)'dir.

Cam Elyaf Takviyeli PP-R Boruda Termal Genleşme

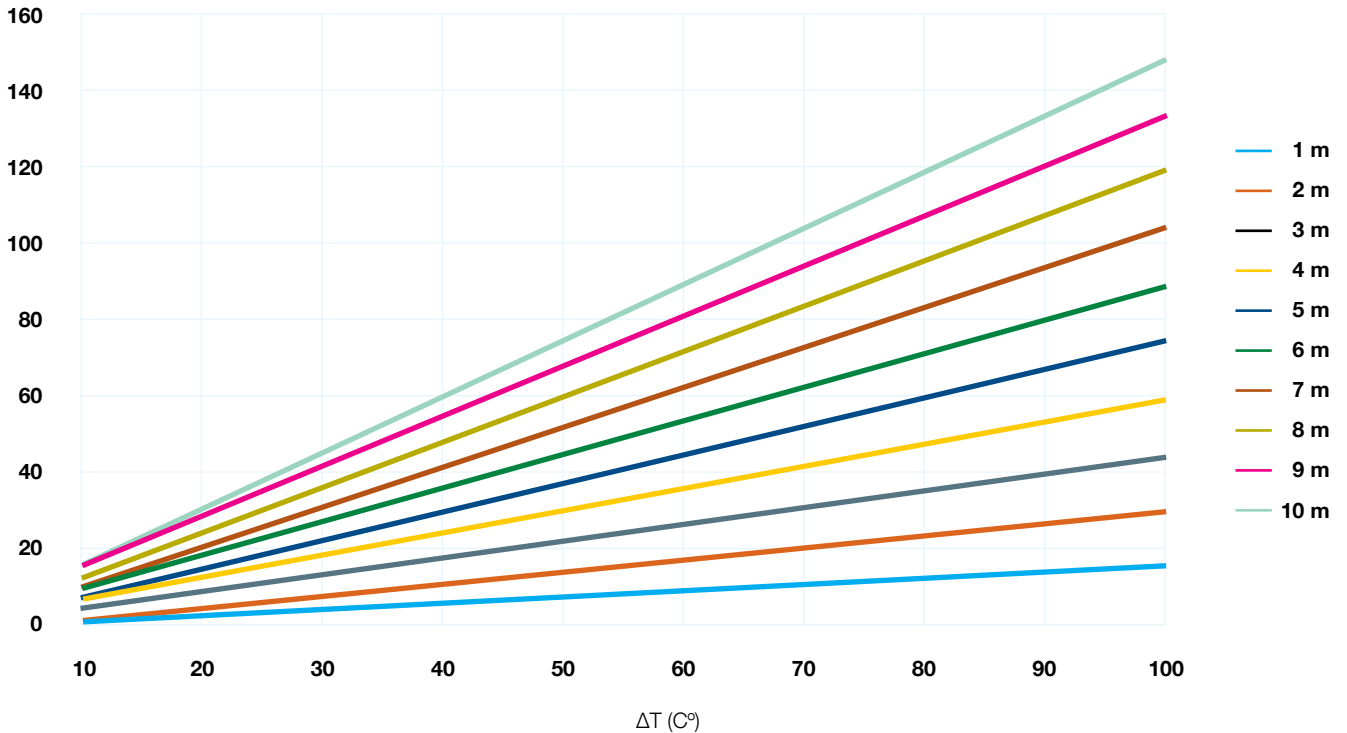

PP-R Alüminyum Folyo Takviyeli Boru

Bu borular üç katmandan oluşur: boru ve kaplama, aralarında alüminyum folyo bulunan PP-R'den yapılmıştır. Alüminyum folyo, sargı kaynağı ile ve alüminyum folyo ile PP-R tabakası arasındaki mekanik bağlantıyı kurmak için özel bir PP kaplama filmi kullanılarak yapıştırılır.

Özellikler

- Düşük termal genişleme
- Oksijen bariyer
- Düşük ısı kaybı
- Basınç ve sıcaklığa karşı yüksek direnç
- Kolay kurulum, şekillendirme ve uygulama
- Hijyenik
- Kimyasallara karşı dirençli
- Pürüzsüz olması sebebiyle düşük basınç kaybı

Oksijen Bariyer

Oksijen penetrasyonu, radyatör ve ısıtıcı cihazını aşındırarak çalışma ömrünü kısaltır. Atmosferik havadan oksijen difüzyonu, sisteme oksijen girişinin en yaygın yollarından biridir. Plastik borular bu penetrasyonu engellemez. Alüminyum tabaka, oksijen geçirmezliği sağlayarak radyatörün ve ısıtıcı cihazın ömrünü artırır.

Alüminyum Folyo Takviyeli PP-R Boruda Termal Genleşme

Termal genişlemenin hesaplanması aşağıdaki gibidir:

$$\Delta L = L * \Delta T * \Phi$$

ΔT = Ortam sıcaklığı ile su sıcaklığı arasındaki fark Kelvin derece (K) veya Santigrat (°C) cinsinden.

ΔL = Uzunluk değişimi (mm)

L = Borunun başlangıç uzunluğu (m)

Φ = Doğrusal termal genişleme katsayısı. Alüminyum folyo takviyeli PP-R boruları için Φ değeri $0,30 * 10^{-4}$ (K-1)'dir.

Alüminyum Folyo Takviyeli PP-R Boruda Termal Genleşme

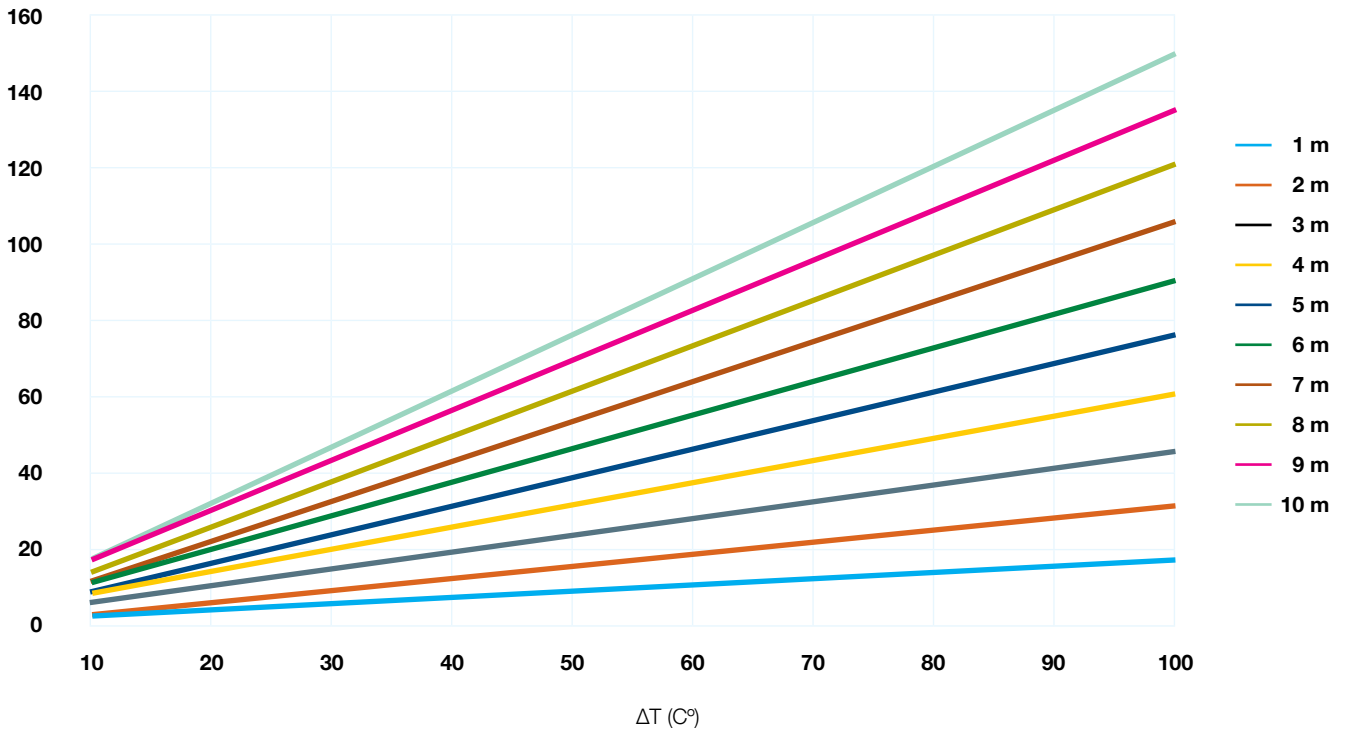

Standart Boru, Cam Elyaf Boru ve Alüminyum Folyo Takviyeli PP-R Boru Arasında Genişleme Karşılaştırması

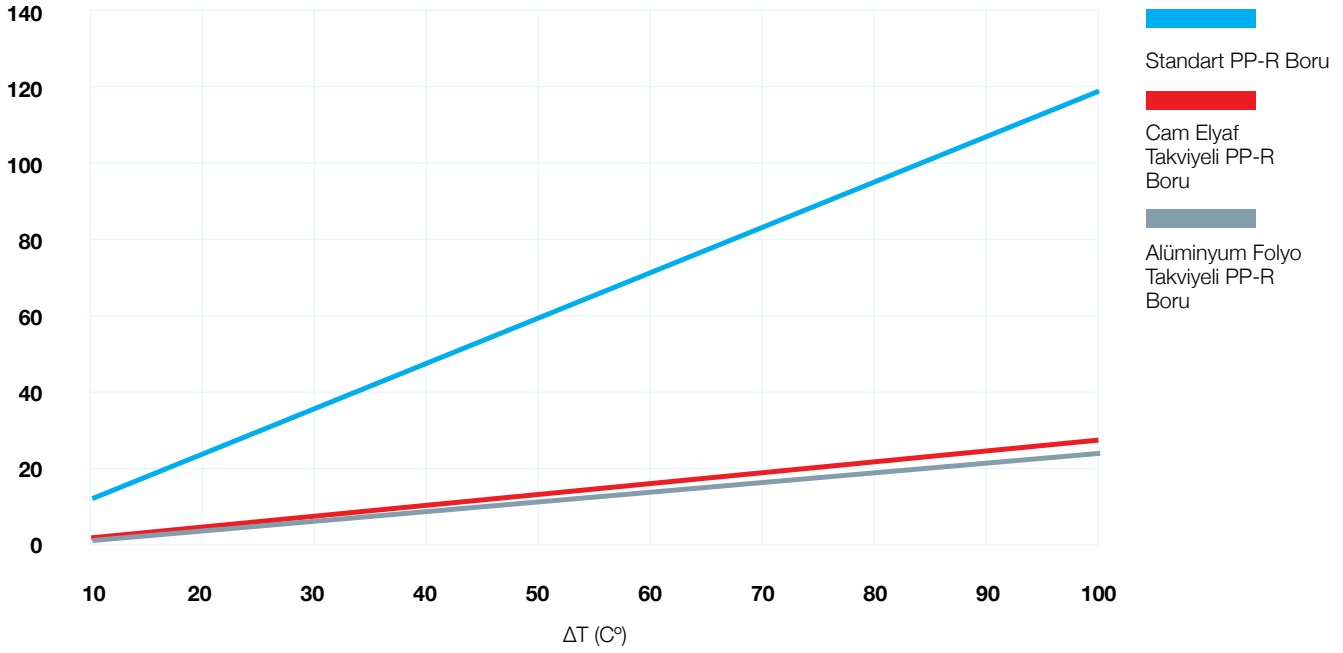

Kaynak Tekniği

PP-R borular ve bağlantı parçaları soket kaynağı ile birleştirilirler. Bu işlem kaynak makinesi kullanılarak yapılır. Tesisatın kullanım ömrü ve kalitesi, doğru ve tekniğine uygun yapılan kaynak ve bağlantılar ile doğrudan ilişkilidir. Boru ve bağlantı parçalarını birbirine kaynaklamak sadece birkaç saniye süren bir işlemdir. **Doğru kaynak tekniğini sıralamak gerekirse aşağıdakiler gibi sıralanabilir;**

- Kaynak yapılacak boru ve ek parçaların kaynak yüzeyleri temizlenir.
- Kaynak yapılacak boru ve bağlantı parçaları boyutuna uygun teflon kaplanmış uygun paftalar kaynak makinesinin üzerinde hazırlanır.
- Kaynak makinesi kaynak yapılmadan önce 270°C ±10 gelecek şekilde ısıtılır.
- Kaynak yapılacak boru, boru eksenine dik olarak düzgün bir biçimde kesilir.
- Boru kaynak mesafesi boru üzerinde işaretlenir. (Kaynak derinlikleri aşağıdaki tabloda belirtilmiştir.)
- Boru, boru paftasına bağlantı parçası, bağlantı parçası paftasına karşılıklı olarak yavaşça ısıtılarak işaretli kaynak derinliği noktasına kadar yerleştirilir.
- Kaynak makinesindeki paftalarda birkaç saniye ısıtılan boru ve bağlantı parçaları paftalardan çıkarılır ve birleştirilerek kaynak edilir.
- Kaynağın tamamlanarak, daha sağlıklı olması açısından herhangi bir işlem yapmadan önce kaynak soğuyana dek beklenmelidir.



Dış Çap (mm)	Isıtma Süresi (sn)	Birleştirme Süresi (sn)	Soğutma Süresi (dk)	Kaynak Derinliği (mm)
20	5	4	2	14,5
25	7	4	3	16
32	8	6	4	18
40	12	6	4	20,5
50	18	6	5	23,5
63	24	8	6	27,5
75	30	8	8	31
90	40	8	8	35,5
110	50	10	8	41,5
125	60	10	8	46,5

Montaj Sonrası Test Prosedürü

Test prosedürünü başlatmak için montajdan sonra sistem kontrol edilmelidir, lütfen aşağıdaki adımları takip edin.

-Sistemdeki tüm vanalar kapatılmalıdır.

-Sistemi doldururken, ilk ana vana hafifçe açılır.

-Güçlü basınç etkilerinden kaçınmak için, boru hattının en yüksek ve en uzak bölümlerdeki kullanım noktalarından hava basıncı düşürmelidir.

-Her bölgenin vanalarının açılmasıyla ayrı testler yapılır.

Kurulumun montajını bitirirken, aşağıdaki test prosedürü izlenerek sistemin kalite kontrolü yapılmalıdır. Basınç testi iki aşamada yapılmalıdır.

1. İlk aşama için; test basıncı izin verilen çalışma basıncı artı 5 bar basınca eşit olmalı ve 30 dakika içersin de 10'ar dakikalık aralıklarla iki kez tekrarlanmalıdır. Daha sonra 30 dakika sonrasında basıncın 0,6 bar 'dan daha fazla düşüp düşmediği ve sızıntı olup olmadığı kontrol edilmelidir.

2. İkinci aşama, birinci aşamayı aralıksız takip etmeli ve çalışma basıncı artı 5 bar basınç 2 saat boyunca verilmeli ve daha sonra basıncın 0,2 bar'dan fazla düşüp düşmediği ve boru tesisatında herhangi bir sızıntı belirtisi olup olmadığı kontrol edilmelidir.

Test sonrası herhangi bir yerde su sızması ve prosedürde belirtilen basınç değerinden fazla kayıp yoksa tesisat kapatılmalı ve uzun süre kullanılmayacaksa donmaya karşı boşaltılmalıdır. Eğer yukarıda verilen değerlere aykırı bir ölçüm söz konusu olursa sızdıran boru hattı kontrol edilmeli ve gerekli onarım yapıldıktan sonra test tekrarlanmalıdır.

Tesisattaki Genleşmelerin Telifisi

Borular zeminin altına veya üstüne monte edilebilir. Kurulum çok kolay ve hızlıdır. Bununla birlikte, polipropilen boruları monte ederken aşağıdaki basit noktalara dikkat etmek gerekir.

Omega ve U parçaları, sıcak hatlardaki borularda kullanılmak için tasarlanmıştır. Bu parçalar, düz borulardaki genleşmeleri telafi etmek için kullanılırlar. Omega ve U parçaları yerine metal kompensatörler de kullanılabilir.

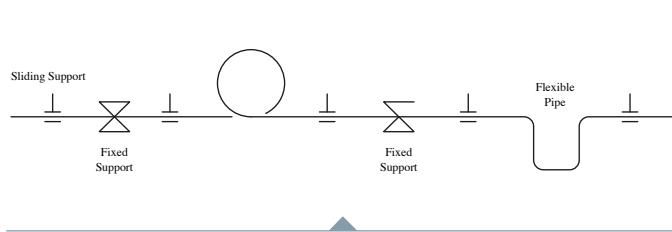

Şekil 1- Omega ve U kısmı

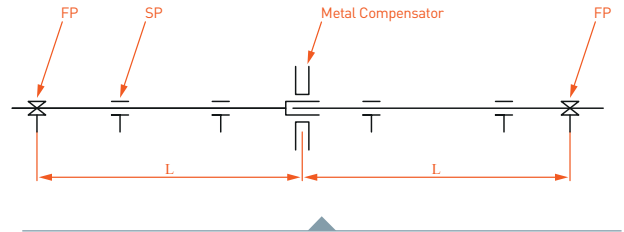

Şekil 2- Metal Dengeleyici

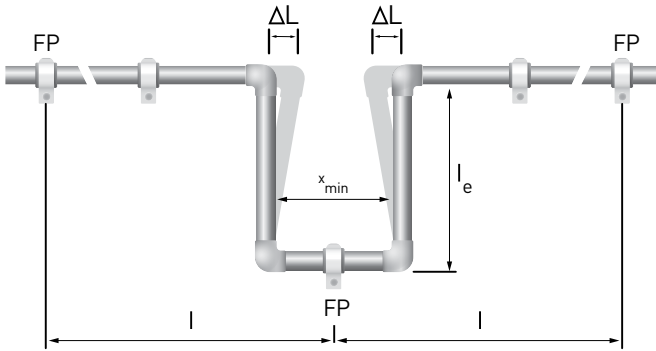

Şekil 3-Bükme kısmının mesafesi

Bükme kısmının uzunluğu aşağıdaki denklem ile hesaplanır:
 $Le = k * d * \Delta L$

Le = Bükme parçasının uzunluğu (U kısmı, mm)

d = Borunun dış çapı (mm)

ΔL = Uzunluk değişimi (mm)

k = Malzemeye bağlı sabit (PP için 15)

FP: Sabitleme noktası, destek noktası.

SP: kayar nokta, destek noktası.

KELEPÇE DESTEK MESAFELERİ

Standart PP-R Boruların Kelepçe Destek Mesafeleri (cm)

Sıcaklık Farkı ΔT (°C)	Standart PP-R Boru Çapı (mm)									
	20	25	32	40	50	63	75	90	110	125
0	85	105	125	140	165	190	205	220	250	270
20	60	75	90	100	120	140	150	160	180	195
30	60	75	90	100	120	140	150	160	180	195
40	60	70	80	90	110	130	140	150	170	185
50	60	70	80	90	110	130	140	150	170	185
60	55	65	75	85	100	115	125	140	160	175
70	50	60	75	80	95	105	115	125	140	150

Cam Elyaf Takviyeli PP-R Boruların Kelepçe Destek Mesafeleri (cm)

Sıcaklık Farkı ΔT (°C)	Cam Elyaf Takviyeli PP-R Boru Çapı (mm)									
	20	25	32	40	50	63	75	90	110	125
0	115	130	150	165	185	215	240	260	280	295
20	90	100	115	130	145	165	185	200	215	225
30	90	100	115	130	145	165	185	200	210	220
40	80	90	105	120	135	155	175	190	200	210
50	80	90	105	120	135	155	175	190	180	190
60	70	80	100	115	130	145	165	180	175	180
70	65	75	90	105	120	135	155	175	175	180

Alüminyum Folyo Takviyeli PP-R Boruların Kelepçe Destek Mesafeleri (cm)

Sıcaklık Farkı ΔT (°C)	Alüminyum Folyo Takviyeli PP-R Boru Çapı (mm)									
	20	25	32	40	50	63	75	90	110	125
0	155	170	195	220	245	270	285	300	325	345
20	120	130	150	170	190	210	220	230	250	265
30	120	130	150	170	190	210	220	230	240	250
40	110	120	140	160	180	200	210	220	210	220
50	110	120	140	160	180	200	210	220	210	220
60	100	110	130	150	170	190	200	210	200	210
70	90	100	120	140	160	180	190	200	200	200

KİMYASAL DİRENÇ

Polipropilen, çok yüksek kimyasal dirence sahip bir polimerdir. Kimyasal direnç, bileşim, kalite durumu, eğilim zamanı, konsantrasyon ve sıcaklık gibi faktörlere göre değişir. Aşağıda gösterilen tablolar farklı sıcaklık ve konsantrasyonlarda kimyasal direnç vermektedir.

S : Doymuş çözelti
f : Dayanıkl
p : Kısmen dayanıklı
n : Dayanıkl değil

Ürünler	Yoğunluk	Sıcaklık		
	%	20 C°	60 C°	100 C°
Akümülatör Asidi		f	f	
Asedik Buzul Asidi	100	f	p	n
Asetik Asit	50	f	f	
Asetik Asit	10	f	f	
Asetik Anhidrit	100	f		
Aseton	100	f	p	n
Akrilonitril	100	p		
Şap	All	f	f	
Amonyak	High	f	f	

Ürünler	Yoğunluk	Sıcaklık		
	%	20 C°	60 C°	100 C°
Amonyak	10	f	f	
Amonyak	100	f	f	
Amonyum Asetat	All	f	f	f
Amonyum Karbonat	All	f	f	
Amonyum Klorür	All	f	f	f
Amonyum Nitrat	All	f	f	f
Amonyum Metafosfat	S	p	p	p
Amonyum Fosfat	All	f	f	f
Amonyum Sülfat	S	p	p	p
Amonyum Bikarbonat	S	p	p	
Hayvansal Pişirme Yağı		f	p	
Araba Anti-Frizi		f	f	
Kral Suyu		f	n	
Barium Klorür	All	f	f	f
Bira		f		
Benzaldehit		f	f	
Benzaldehit	S	f	f	f
Benzen		p	n	
Benzoik Asit	S	f	f	p
Benzoil Klorür	100	n		
Acı Badem Yağı		f		
Çamaşır Suyu	12.50%	p	p	
Boraks				
Borik Asit	100	f	f	
Borik Asit	S	f	f	
Brendi		f		
Brom	100	n		
Brom	High	n	n	
Brom	Low	n	n	
Bütan	100	f		
Bütan (P)	100	f	f	
Tereyağı		f	f	
Bütil Alkol	100	f	f	
Kalsiyum Nitrat	S	f	f	
Kafur		f		
Karbon Tetra Klorür	100	p	n	
Klor	100	n		
Klor (Kuru)	100	n	n	n
Klor (Islak)	10	p	n	n
Klorasülfonik	100	n	n	

Ürünler	Yoğunluk	Sıcaklık		
	%	20 C°	60 C°	100 C°
Kromik Asit	S	f	n	
Chromium (3) Tuzları				
Chromium (6) Tuzları				
Sitrik Asit	S	f	f	f
Kakao		f	f	p
Morina Karaciğeri Yağı		f		
Cresol	100	f	p	
Cresol	S	f	p	
Kresol Yağı		f		
Sikloheksan	100	f		
Cycloexanol	100	f	p	
Cycloexanon	100	f	n	
Decahydronaphthlene	100	p	n	n
Dioksan	100	f	p	n
Arıtılmış Su	100	f	f	n
Motor Yağı		f	p	
Etil Alkol	100	f		
Etil Alkol	96	f	f	
Etil Alkol	50	f	f	
Eterler	100	f	p	
Etil Alkol (Denatüre)	10	f	f	
Etil Klorürler	100	n		
Etilen Klorürler	100	p	p	
Etilen Tetraklorür	100	p	n	
Formaldehit	40	f	f	
Formaldehit	30	f	f	
Formaldehit	10	f	f	
Formik Asit	98	f	p	
Formik Asit	90	f		
Formik Asit	50	f	f	
Formik Asit	10	f	f	f
Meyve Suyu		f	f	
Fumik Sülfürik Asit		n	n	n
Galvanik Çözeltiler		f	f	
Gliserin	100	f	f	
Gliserin	High	f	f	
Gliserin	Low	f	f	f
Glikol	100	f	f	
Glikol	High	f	f	
Glikol	Low	f	f	f

Ürünler	Yoğunluk	Sıcaklık		
	%	20 C°	60 C°	100 C°
Heptan	100	f	p	
Hekzan	100	f	p	
Bal		f	f	
Hidrobromik Asit	10	f	f	
Hidroflorik Asit	40	f	f	
Hidrojen Peroksit Su	30	f	p	
Hidrobromik Asit	High	f	f	
Hidrojen Peroksit Su	10	f	f	
Hidrojen Peroksit Su	3	f	f	f
Mürekkep		f	f	
Izo Oktan	100	f	p	
Laktik Asit	90	f	f	
Laktik Asit	50	f	f	
Laktik Asit	10	f	f	f
Likit Su	100	f	f	f
Kireç Taşı		f	f	f
Keten Tohumu Yağı		f	f	
Civa		f	f	
Civa Tuzları	100			
Metil Alkol	50	f	f	
Metil Alkol	100	f	f	
Metil Klorür	100	p		
Metil Etil Keton	100	f	p	
Metilen Formaldehit		f		
Süt		f	f	p
Mineralli Su		f	f	f
Neft		f	p	
Naftalin	100	f		
Nitro Benzen	100	p	p	
Normal Benzin		p	n	
Yağ		n	n	
Oleik Asit	100	f		
Zeytin Yağı		f	f	
Nitrik Asit	50	p	n	
Nitrik Asit	25	f	f	
Nitrik Asit	10	f	f	
Oksalik Asit	S	f	f	f
Ozon	<0.5 ppm	p	p	
Parafin	100	f	f	n
Petrol	100	f	p	

Ürünler	Yoğunluk	Sıcaklık		
	%	20 C°	60 C°	100 C°
Fenilamin		f	p	
Fenilamin Metil Keton	100	p	p	
Fosforik Asit	S	f	p	
Fosforik Asit	50	f	f	
Fosforik Asit	10	f	f	f
Potasyum Karbonat	S	f	f	
Potasyum Klorat	S	f	f	
Potasyum Klorür X	S	f	f	f
Potasyum Dikromat	S	f	f	f
Potasyum Hidroksit	50	f	f	
Potasyum Hidroksit	25	f	f	
Potasyum Hidroksit	10	f	f	
Potasyum Hipoklorit	5	f		
Potasyum İyodür	S	f	f	
Potasyum Nitrat	S	f	f	
Deniz Suyu		f	f	f
Şampuan		f	f	
Silikon Yağı		f	p	
Sabun Çözeltisi	S	f	f	
Sabun Çözeltisi	10	f	f	f
Sodyum Bikarbonat	S	f	f	f
Potasyum Sülfate	S	f	f	f
Propan ®	100	f	f	f
Propan	100	f	f	f
Piridin	100	f	p	
Sodyum Karbonat	S	f	f	
Sodyum Karbonat	10	f	f	f
Sodyum Klorat	5	f		
Sodyum Klorat	25	f	f	
Sodyum Klorit	S	f	f	f
Sodyum Disülfid	S	f	f	f
Sodyum Hidroksit	100	f	f	
Sodyum Hidroksit	50	f	f	
Sodyum Hidroksit	25	f	f	
Sodyum Hidroksit	10	f	f	
Sodyum Nitrat	S	f	f	
Sodyum Nitrit (P)	S	f		
Sodyum Perborat	S	f	f	f
Sodyum Fosfat	S	f	f	f

Ürünler	Yoğunluk	Sıcaklık		
	%	20 C°	60 C°	100 C°
Sodyum Sülfat	S	f	f	f
Sodyum Sülfid	S	f	f	
Çözünebilir Kahve		f	f	f
Soya Fasulyesi Yağı		f	p	
Sülfokromik Asit		n	n	
Sülfür	100	f	f	f
Sülfürik Asit	96	f	p	
Sülfürik Asit	50	f	f	
Sülfürik Asit	25	f	f	
Sülfürik Asit	10	f	f	f
Kükürt Anhidrit	Low	f	f	
Spirits		f		
Kalay Klorür	S	f	f	
Nişasta	All	f	f	
Sitrik Asit	100	f		
Süksinik Asit	100	f	f	
Süper Benzin		p	n	
Sentetik Temizleyici		f	f	f
Katran		f	p	
Tartarik Asit	S	f	f	
Tartarik Asit	10	p	p	
Tetrahidrofuran	100	p	n	
Tetrahidro Naftalin	100	p	n	
Thea		f	f	p
Tiyofen	100	p	n	
Tolüen	100	p	n	
Domates Suyu		f	f	
Diş Macunu		f	f	
Trichloroethylene	100	p	p	
Türpentin		n	n	n
Türpentin Yağı		p	n	
İki Zamanlı Motor Yağı		p	p	
Daktilo Yağı		f	p	
Üre	S	f	f	
Vazelin		f	p	
Bitkisel Pişirme Yağı		f	p	
Su	100	f	f	f
Krema		f		
Viski	40	f		
Ksilen	100	p	n	

Ek Parçaların Metal İnsertlerinin Ham maddesi Olan Pirinç MS58 İçeriği

Bakır

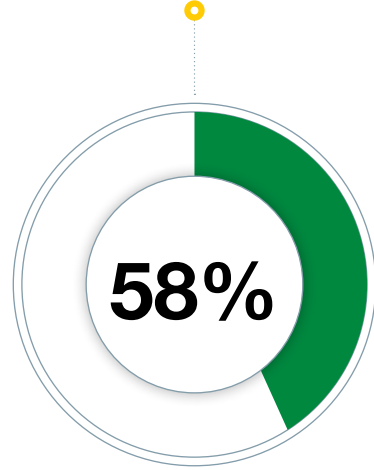

Çinko

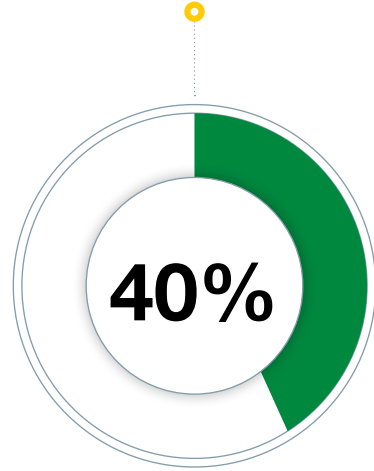

Diğerleri

Pb, Sn, P, Mn, Fe, Ni, Si, Mg, Cr, Al, etc.

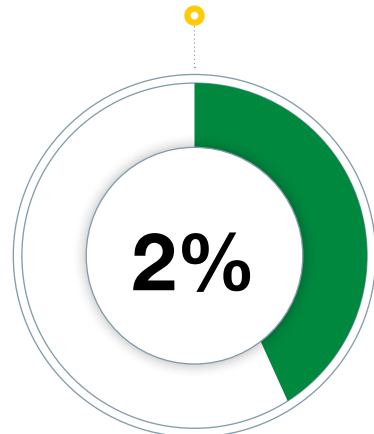

Kullanılan Normlar

TS-DIN 1988

İçme suyu hat montajı.

TS-DIN 2999

Boru ve Ek Parçaları için Whitworth boru dişleri.

TS-DIN 4109

Bina yapımında ses yalıtımı.

TS-DIN 8077

Polypropylene (PP-R) boru boyutları.

TS-DIN 8078

Polypropylene (PP-R) boru genel kalite gereklilikleri ve testleri.

TS-DIN 16928

Boru bağlantıları ve bileşenleri - Termoplastik malzeme boruları; boru bağlantıları, boru elemanları, döşeme; genel talimatlar.

TS-DIN 16962 (6-9)

Polipropilen (PP-R) basınçlı boru hatları için boru bağlantıları ve elemanları, tip 1 ve 2; soket kaynağı için enjeksiyon kalıplı dirsekler, boyut.

TS-DIN 16962.5

Boru bağlantıları ve polipropilen bileşenleri (PP-R) Basınç altındaki borular için, Bölüm 5: Genel kalite gereklilikleri, test.

TS-DVS 2207.11

Plastik borular için kaynak düzenlemeleri.

TS-DVS 2208.1

Termoplastik boruların kaynağı için makine ve cihazlar.

TS-EN ISO 15874 -2-3

Sıcak ve soğuk su tesisatı için plastik boru sistemleri polipropilen (PP-R).

TSE K 28

Çok katmanlı cam Elyaf borular Polipropilen (PP-R) - sıcak ve soğuk su sistemleri için kullanılan basınçlı borular.

TS 9937

Polipropilenden (PP-R) Plastik Borular - genel amaçlı.

Taşıma ve Depolama

- Boruyu ve bağlantı parçalarını güneşten ve yağmurdan korunarak saklayın. UV radyasyonuna uzun süre maruz bırakmayın.



- 0°C'nin altındaki sıcaklıklarda saklamayın. Etkiler borular üzerinde çatlaklar oluşturabilir.



- Sert ve keskin nesnelerin etkisini koruyun.



- Oldukça dayanıklı olmasına rağmen, lütfen yükleme ve boşaltma sırasında atmayın.



- Lütfen dikkatli hareket edin ve istifleyin.



PE-RT Boru nedir?

PE-RT boru (Polietilen - Raised Temperature Resistance) ısıya dayanıklı PE borunun kısaltılmış halidir. PE-RT borular tecrübeli ve uzman ekibimiz tarafından son teknoloji ile donatılmış makinelerde ISO 22391-2 standardına uygun olarak yüksek kalitede üretilmektedir.

PE-RT Boru Özellikleri

- PE-RT borular çevre ile dost geri dönüştürülebilir termoplastik malzemelerden olan Tip 2 PE-RT ham maddeden üretilmektedir.
- PE-RT borular esneklik özelliği sayesinde soğuk havalarda ısıtmaya gerek kalmadan kolayca döşenebilir.
- PE-RT borular özel olarak geliştirilen ham madde nedeniyle yüksek ısı ve basınca dayanıklı olup kimyasallara karşı yüksek dirence sahiptir.
- PE-RT borular içme suyunda kullanılabilir.
- Borular üretildikten sonra kangallar halinde ambalajlanır ve kolayca taşınır.
- Boruların dış çapı 16 mm, et kalınlığı ise 2 mm' dir.
- Kırmızı, Mavi iki renk kılıflı, standart ve oksijen bariyerli olarak çeşitleri mevcuttur.

Oksijen Bariyerli PE-RT Boru Özellikleri

Bariyerli PE-RT borular özel olarak geliştirilmiş EVOH katmanı sayesinde oksijen geçirmez. Bu sayede mevcut sistemde yer alan pompa, vana, radyatör gibi bağlantı elemanlarının korozyona uğramasının önüne geçilir. Böylelikle sistemde yer alan bağlantı elemanlarının servis ömrü uzar, bakım ve onarım maliyetleri en aza inmiş olur.

PE-RT Boru Kullanım Alanları

- PE-RT borular;
- Sıcak & soğuk temiz su tesisatları,
 - Merkezi ısıtma,
 - Yerden ısıtma,
 - Radyatör bağlantıları ve
 - Endüstriyel uygulamalarda kullanılmaktadır.

PE-RT Borunun Diğer Borulardan Farkı Nedir?

Piyasada bulunan diğer tip borular özellikle soğuk hava koşullarında esnekliğini kaybeder. Sistemin döşenebilmesi için ısıtma cihazlarına ihtiyaç duyulur. PE-RT borular ham madde yapısı gereği esnek yapıya sahiptirler ve böylelikle soğuk havalarda ısıtmaya ihtiyaç duymadan döşenebilir.

PE-RT Tip 2 ham maddesi sayesinde PE-RT borularda PE-X borularda var olan çapraz bağlanmaya ihtiyaç duyulmadan yüksek sıcaklıkta uzun süreli hidrostatik mukavemet sağlanır. PE-RT boruların yüksek sıcaklıkta uzun dönem hidrostatik dayanıklılık sağlaması için çapraz bağlanma gerektirmeyişi PE-RT malzemesinin eşsiz özelliğidir. Bu özellik sayesinde çevre dostu ve geri dönüşümlü boru özelliğini kazanmaktadır.

PE-X borularda olduğu gibi çapraz bağlanmayı sağlayan herhangi bir kimyasal madde içermediğinden içme suyunda da kullanımı uygundur. İnsan sağlığına zararı yoktur.

Yerden ısıtma ve radyatör sistemlerinde iki tip plastik boru kullanılmaktadır. Bunlardan biri PE-X (polietilen cross-linked , PE çapraz bağlı) diğeri de PE-RT (polietilen raised temperature resitance)'dir. PE-X ve PE-RT boruların her ikisi de polietilen ham maddesinden üretilmektedir. PE-X boruların PE-Xa, PE-Xb, PE-Xc olarak isimlendirilen alt türleri mevcuttur. PE-X borularda c'den a'ya doğru borunun ısıya ve basınca dayanımı artmaktadır. Buna karşılık borularda esneklik özellikleri azalmaktadır. Boruların uygulama esnasında esneklik kazanması için ısıtılarak döşenmesi gerekmektedir. Bu durum zaman ve işçilik kayıplarına neden olmaktadır. PE-RT borular ise yapısında yer alan özel olarak geliştirilmiş PE-RT Tip 2 ham maddesi sayesinde en yüksek esneklik özelliği kazanılırken aynı zamanda borunun yüksek ısı ve basınç dayanımı özellikleri de korunmaktadır. Böylelikle PE-RT borular ısıtma gerektirmeden soğuk olarak da döşenebilmektedir. PE-RT borular doğru malzeme seçimi ve doğru montaj teknikleri ile döşendiğinde 50 yıl ömre sahiptirler.

PE-RT Boru Basınç Dayanım Tablosu

16x2 mm PE-RT Boru (SF=1,5)		
Sıcaklık °C	Yıl	Basınç (Bar)
20	1	18,6
	5	18,2
	10	18,1
	25	17,9
	50	17,8
30	1	16,9
	5	16,6
	10	16,5
	25	16,3
	50	16,1
40	1	15,3
	5	15,0
	10	14,8
	25	14,6
	50	14,5
50	1	13,6
	5	13,3
	10	13,2
	25	13,0
	50	12,9
60	1	12,0
	5	11,7
	10	11,5
	25	11,4
	50	11,2
70	1	10,3
	5	11,1
	10	9,9
	25	9,8
	50	9,6
80	1	8,8
	5	8,5
	10	8,4
	25	8,2
95	1	6,5
	5	6,3
	10	6,2

Çocuklarımıza
YAŞANABİLİR ŞEHİRLER
Borçluyuz.



formül[®]

**PP-R BORU ve
EK PARÇALARI**

2

PP-R BORU PN 10

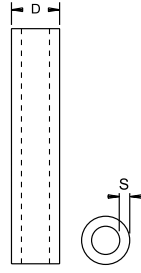
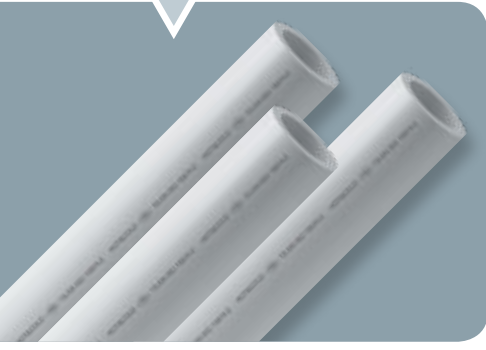

Kod	Ölçü (ø)	S	D	Miktar	Fiyat ₺
DUZ-200010	20	1.9	20.3	140/4.00	9,430
DUZ-250010	25	2.3	25.3	100/4.00	13,630
DUZ-320010	32	2.9	32.3	60/4.00	23,100
DUZ-400010	40	3.7	40.4	40/4.00	39,410
DUZ-500010	50	4.6	50.5	24/4.00	57,780
DUZ-630010	63	5.8	63.6	20/4.00	97,160
DUZ-750010	75	6.8	75.7	12/4.00	123,860
DUZ-900010	90	8.2	90.9	8/4.00	214,120
DUZ-110010	110	10	111	4/4.00	297,390
DUZ-125010	125	11.4	126.2	4/4.00	548,890

PP-R BORU PN 16

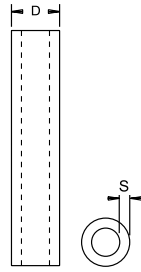
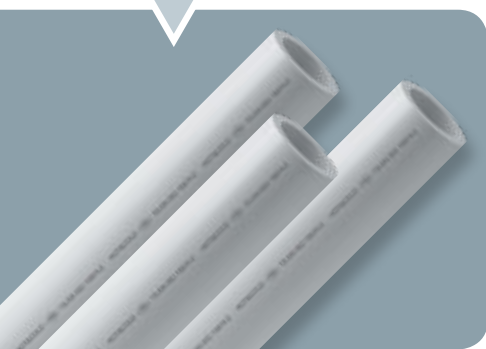

Kod	Ölçü (ø)	S	D	Miktar	Fiyat ₺
DUZ-200016	20	2.8	20.3	140/4.00	11,300
DUZ-250016	25	3.5	25.3	100/4.00	17,700
DUZ-320016	32	4.4	32.3	60/4.00	29,470
DUZ-400016	40	5.5	40.4	40/4.00	45,700
DUZ-500016	50	6.9	50.5	24/4.00	72,850
DUZ-630016	63	8.6	63.6	20/4.00	115,180
DUZ-750016	75	10.3	75.7	12/4.00	164,590
DUZ-900016	90	12.3	90.9	8/4.00	269,310
DUZ-110016	110	15.1	111	4/4.00	401,880
DUZ-125016	125	17.1	126.2	4/4.00	591,680

PP-R BORU PN 20

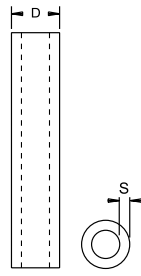
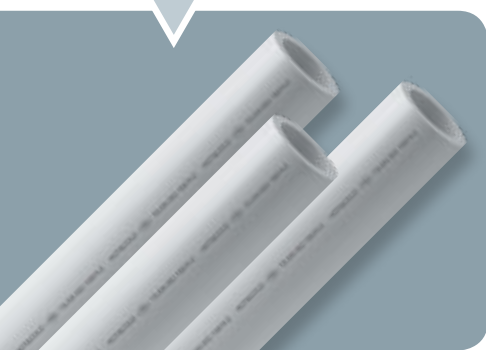

Kod	Ölçü (ø)	S	D	Miktar	Fiyat ₺
DUZ-200020	20	3.4	20.3	140/4.00	13,120
DUZ-250020	25	4.2	25.3	100/4.00	20,150
DUZ-320020	32	5.4	32.3	60/4.00	38,020
DUZ-400020	40	6.7	40.4	40/4.00	55,860
DUZ-500020	50	8.3	50.5	24/4.00	87,670
DUZ-630020	63	10.5	63.6	20/4.00	140,680
DUZ-750020	75	12.5	75.7	12/4.00	212,520
DUZ-900020	90	15.0	90.9	8/4.00	342,360
DUZ-110020	110	18.3	111	4/4.00	509,650
DUZ-125020	125	20.8	126.2	4/4.00	656,900

PP-R FOROXİ BORU PN 25

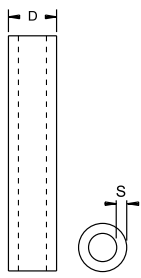
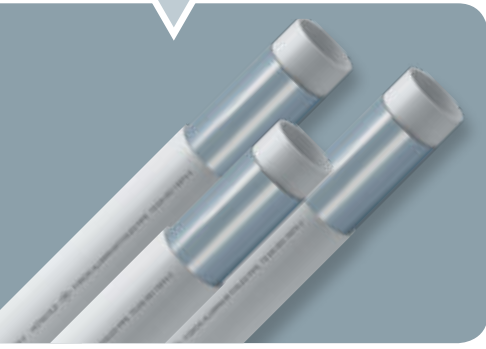

Kod	Ölçü (ø)	S	D	Miktar	Fiyat ₺
OFL-200025	20	3.4	20.3	140/4.00	23,800
OFL-250025	25	4.2	25.3	100/4.00	33,900
OFL-320025	32	5.4	32.3	60/4.00	56,500
OFL-400025	40	6.7	40.4	40/4.00	78,870
OFL-500025	50	8.3	50.5	24/4.00	120,080
OFL-630025	63	10.5	63.6	20/4.00	184,380
OFL-750025	75	12.5	75.7	12/4.00	315,970
OFL-900025	90	15.0	90.9	8/4.00	455,000

Kod	Ölçü (ø)	S	D	Miktar	Fiyat ₺
DGF-200020	20	2.8	20.3	140/4.00	13,600
DGF-250020	25	3.5	25.3	100/4.00	21,200
DGF-320020	32	4.4	32.3	60/4.00	33,840
DGF-400020	40	5.5	40.4	40/4.00	50,280
DGF-500020	50	6.9	50.5	24/4.00	82,400
DGF-630020	63	8.6	63.6	20/4.00	126,600
DGF-750020	75	10.3	75.7	12/4.00	191,250
DGF-900020	90	12.3	90.9	8/4.00	308,120
DGF-110020	110	15.1	111	4/4.00	458,670
DGF-125020	125	17.1	126.2	4/4.00	640,370

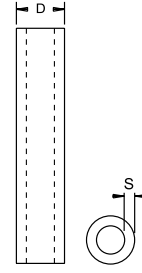

PP-R KOMPOZİT BORU PN 20



Kod	Ölçü (ø)	S	D	Miktar	Fiyat ₺
DGF-200025	20	3.4	20.3	140/4.00	16,200
DGF-250025	25	4.2	25.3	100/4.00	24,300
DGF-320025	32	5.4	32.3	60/4.00	44,030
DGF-400025	40	6.7	40.4	40/4.00	66,170
DGF-500025	50	8.3	50.5	24/4.00	103,190
DGF-630025	63	10.5	63.6	20/4.00	167,990
DGF-750025	75	12.5	75.7	12/4.00	268,230
DGF-900025	90	15.0	90.9	8/4.00	391,700
DGF-110025	110	18.3	111	4/4.00	581,670
DGF-125025	125	20.8	126.2	4/4.00	752,720

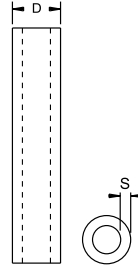

PP-R KOMPOZİT BORU PN 25



Kod	Ölçü (ø)	S	D	L	Miktar	Fiyat ₺
OMG-200020	20	3.4	20.3	350	85	24,290
OMG-250020	25	4.2	25.3	350	45	38,870
OMG-320020	32	5.4	32.3	350	22	58,300
OMG-400020	40	6.7	40.4	350	15	93,970

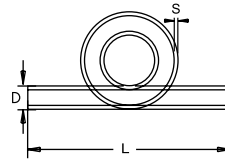

PP-R OMEGA PN 20

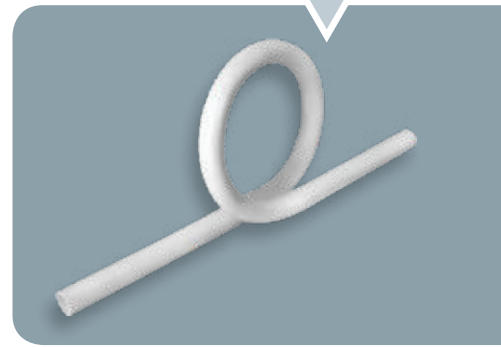

Kod	Ölçü (ø)	S	D	L	Miktar	Fiyat ₺
KVS-200020	20	3.4	20.3	350	160	6,380
KVS-250020	25	4.2	25.3	350	100	10,040
KVS-320020	32	5.4	32.3	350	65	19,040
KVS-400020	40	6.7	40.4	350	40	29,890

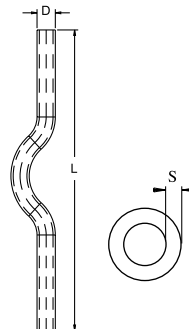

PP-R KAVİS PN 20



PP-R KAVİS MANŞONLU PN 25 - UZUN

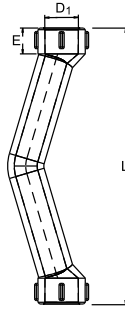

Kod	Ölçü (ø)	ø d ₁	E	L	Miktar	Fiyat ₺
MKV-200000	20	19.5	14.5	162	125	6,110
MKV-250000	25	24.5	16	200	80	9,710
MKV-320000	32	31.5	18	240	30	24,500

PP-R KAVİS MANŞONLU PN 25 - KISA (C TİP)

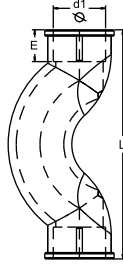

Kod	Ölçü (ø)	ø d ₁	E	L	Miktar	Fiyat ₺
MKK-200000	20	19.5	14.5	86	200	4,540
MKK-250000	25	24.5	16	95	125	7,470
MKK-320000	32	31.5	18	117	60	15,830

PP-R KAVİSLİ DİRSEK PN 25

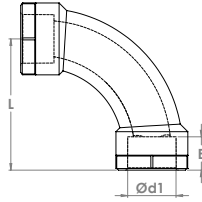

Kod	Ölçü (ø)	ø d ₁	E	L	Miktar	Fiyat ₺
KVD-250000	25	24.5	16	66	125	9,950
KVD-320000	32	31.5	18	83	60	20,830

PP-R UZUN TE PN 25

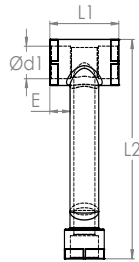

Kod	Ölçü (ø)	ø d ₁	E	L1	L2	Miktar	Fiyat ₺
MTK-200000	20	19.5	14.5	49	146	100	7,250
MTK-250000	25	24.5	16	59	163	70	8,950

PP-R MANŞON PN 25

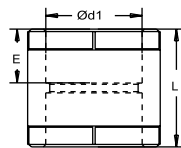

Kod	Ölçü (ø)	Ø d ₁	E	L	Miktar	Fiyat ₺
MAN-200000	20	19.5	14.5	34	600	1,070
MAN-250000	25	24.5	16	37	300	1,730
MAN-320000	32	31.5	18	41	200	3,410
MAN-400000	40	39.4	20.5	45	100	5,710
MAN-500000	50	49.4	23.5	52	60	10,090
MAN-630000	63	62.5	27.5	60	36	19,140
MAN-750000	75	74.2	31	65	24	31,400
MAN-900000	90	89.2	35.5	71	16	50,790
MAN-1100000	110	109	41.5	79	6	85,570
MAN-1250000	125	123.9	46.5	104	4	160,560



Kod	Ölçü (ø)	Ø d1	Ø d2	E1	E2	L	Miktar	Fiyat ₺
RDM-252000	25/20	24.5	19.5	16	14.5	35	400	1,820
RDM-322000	32/20	31.5	19.5	18	14.5	38	300	2,670
RDM-322500	32/25	31.5	24.5	18	16	40	250	3,530
RDM-402000	40/20	39.4	19.5	20.5	14.5	47	150	7,160
RDM-402500	40/25	39.4	24.5	20.5	16	47	150	7,580
RDM-403200	40/32	39.4	31.5	20.5	18	47	125	8,430
RDM-502000	50/20	49.4	19.5	23.5	14.5	50	100	10,540
RDM-502500	50/25	49.4	24.5	23.5	16	50	100	10,960
RDM-503200	50/32	49.4	31.5	23.5	18	50	80	11,790
RDM-504000	50/40	49.4	39.4	23.5	20.5	50	75	12,640
RDM-632000	63/20	62.5	19.5	27.5	14.5	60	40	19,800
RDM-632500	63/25	62.5	24.5	27.5	16	60	40	20,220
RDM-633200	63/32	62.5	31.5	27.5	18	60	40	21,910
RDM-634000	63/40	62.5	39.4	27.5	20.5	65	40	22,750
RDM-635000	63/50	62.5	49.4	27.5	23.5	66	35	23,180

PP-R REDÜKSİYON MANŞON PN 25

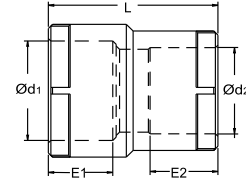

Kod	Ölçü (ø)	Ø d1	E	D	L	Miktar	Fiyat ₺
RDS-252000	25/20	19.5	14.5	25	39	500	1,400
RDS-322000	32/20	19.5	14.5	32	39	400	1,740
RDS-322500	32/25	24.5	16	32	43	300	2,100
RDS-402000	40/20	19.5	14.5	40	39	200	3,600
RDS-402500	40/25	24.5	16	40	43	200	3,670
RDS-403200	40/32	31.5	18	40	48	150	4,120
RDS-502500	50/25	24.5	16	50	43	100	6,260
RDS-503200	50/32	31.5	18	50	48	100	6,400
RDS-504000	50/40	39.4	20.5	50	52	80	7,330
RDS-633200	63/32	31.5	18	63	48	60	14,520
RDS-634000	63/40	39.4	20.5	63	52	60	14,650
RDS-635000	63/50	49.4	23.5	63	60	50	16,310
RDS-754000	75/40	39.4	20.5	75	52	40	19,660
RDS-755000	75/50	49.4	23.5	75	60	40	20,460
RDS-756300	75/63	62.5	27.5	75	67	30	24,680
RDS-905000	90/50	49.4	23.5	90	60	20	39,320
RDS-906300	90/63	62.5	27.5	90	67	20	39,320
RDS-907500	90/75	74.2	31	90	72	16	41,400
RDS-116300	110/63	62.5	27.5	110	67	16	56,170
RDS-117500	110/75	74.2	31	110	72	16	56,170
RDS-119000	110/90	89.2	35.5	110	90	16	66,910
RDS-129000	125/90	89.2	35.5	125	120	6	110,460
RDS-121100	125/110	109	41.5	125	120	5	146,760

PP-R REDÜKSİYON PN 25

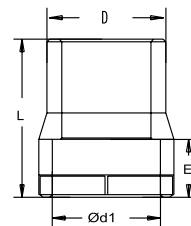

PP-R 90° REDÜKSİYON DİRSEK PN 25

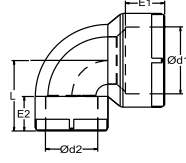

Kod	Ölçü (ø)	Ø d1	Ø d2	E1	E2	L	Miktar	Fiyat ₺
RDD-252000	25/20	24.5	19.5	16	14.5	29	250	3,350
RDD-322500	32/25	31.5	24.5	18	16	33	150	5,230

PP-R 90° KUYRUKLU DİRSEK PN 25

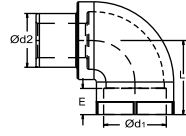

Kod	Ölçü (ø)	Ø d1	Ø d2	E	L	Miktar	Fiyat ₺
KDR-200090	20	19.5	20.3	14.5	23	300	2,870
KDR-250090	25	24.5	25.3	16	25	200	4,690
KDR-320090	32	31.5	32.3	18	28	100	7,300

PP-R 90° DİRSEK PN 25

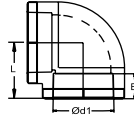

Kod	Ölçü (ø)	Ø d1	E	L	Miktar	Fiyat ₺
DIR-200090	20	19.5	14.5	23	400	1,560
DIR-250090	25	24.5	16	25	250	2,570
DIR-320090	32	31.5	18	28	125	4,700
DIR-400090	40	39.4	20.5	32	60	9,380
DIR-500090	50	49.4	23.5	37	35	16,680
DIR-630090	63	62.5	27.5	54	15	32,280
DIR-750090	75	74.2	31	60	12	50,990
DIR-900090	90	89.2	35.5	76	6	93,410
DIR-110090	110	109	41.5	94	2	159,440
DIR-125090	125	123.9	46.5	110	2	344,660

PP-R İNEGAL TE PN 25

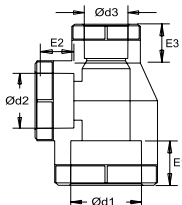

Kod	Ölçü (ø)	Ø d1	E1	Ø d2	E2	Ø d3	E3	Miktar	Fiyat ₺
ITE-202520	20/25/20	19.5	14.5	24.5	16	19.5	14.5	200	3,520
ITE-252020	25/20/20	24.5	16	19.5	14.5	19.5	14.5	150	3,520
ITE-252025	25/20/25	24.5	16	19.5	14.5	24.5	16	200	3,520
ITE-252520	25/25/20	24.5	16	24.5	16	19.5	14.5	150	3,520
ITE-322020	32/20/20	31.5	18	19.5	14.5	19.5	14.5	100	6,330
ITE-322025	32/20/25	31.5	18	19.5	14.5	24.5	16	100	6,330
ITE-322032	32/20/32	31.5	18	19.5	14.5	31.5	18	100	6,330
ITE-322520	32/25/20	31.5	18	24.5	16	19.5	14.5	100	6,330
ITE-322525	32/25/25	31.5	18	24.5	16	24.5	16.0	100	6,330
ITE-322532	32/25/32	31.5	18	24.5	16	31.5	18	100	6,330
ITE-402040	40/20/40	39.4	20.5	19.5	14.5	39.4	20.5	50	12,270
ITE-402540	40/25/40	39.4	20.5	24.5	16	39.4	20.5	50	12,270
ITE-403240	40/32/40	39.4	20.5	31.5	18	39.4	20.5	40	12,270
ITE-502050	50/20/50	49.4	23.5	19.5	14.5	49.4	23.5	30	19,660
ITE-502550	50/25/50	49.4	23.5	24.5	16	49.4	23.5	30	19,660
ITE-503250	50/32/50	49.4	23.5	31.5	18	49.4	23.5	30	19,660
ITE-504050	50/40/50	49.4	23.5	39.4	20.5	49.4	23.5	25	19,660
ITE-632063	63/20/63	62.5	27.5	19.5	14.5	62.5	27.5	24	44,030
ITE-632563	63/25/63	62.5	27.5	24.5	16	62.5	27.5	24	44,030
ITE-633263	63/32/63	62.5	27.5	31.5	18	62.5	27.5	24	44,030

Kod	Ölçü (ø)	Ø d1	E	Miktar	Fiyat ₺
DIR-200045	20	19.5	14.5	500	2,070
DIR-250045	25	24.5	16	300	3,040
DIR-320045	32	31.5	18	125	5,030
DIR-400045	40	39.4	20.5	80	9,830
DIR-500045	50	49.4	23.5	40	17,670
DIR-630045	63	62.5	27.5	20	33,890
DIR-750045	75	74.2	31	15	71,840
DIR-900045	90	89.2	35.5	8	140,190
DIR-110045	110	109	41.5	4	234,780

PP-R 45° DİRSEK PN 25

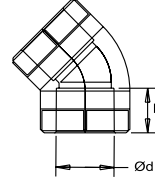

PP-R 45° KUYRUKLU DİRSEK PN 25

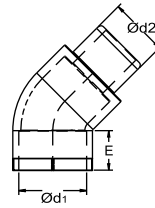

Kod	Ölçü (ø)	Ø d1	Ø d2	E	Miktar	Fiyat ₺
KDR-200045	20	19.5	20.3	14.5	300	2,670
KDR-250045	25	24.5	25.3	16	200	3,960
KDR-320045	32	31.5	32.3	18	100	6,790

Kod	Ölçü (ø)	Ø d1	E	L	Miktar	Fiyat ₺
TEE-200000	20	19.5	14.5	52	250	2,300
TEE-250000	25	24.5	16	59	150	3,330
TEE-320000	32	31.5	18	70	80	6,590
TEE-400000	40	39.4	20.5	82	40	12,020
TEE-500000	50	49.4	23.5	100	25	21,930
TEE-630000	63	62.5	27.5	120	16	42,270
TEE-750000	75	74.2	31	137	10	67,750
TEE-900000	90	89.2	35.5	160	5	114,480
TEE-110000	110	109	41.5	190	2	191,740
TEE-125000	125	123.9	46.5	221	2	422,720

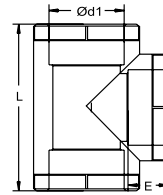

PP-R TE PN 25



Kod	Ölçü (ø)	Ø d1	E1	Ø d2	E2	Ø d3	E3	Miktar	Fiyat ₺
ITE-634063	63/40/63	62.5	27.5	39.4	20.5	62.5	27.5	16	44,030
ITE-635063	63/50/63	62.5	27.5	49.4	23.5	62.5	27.5	16	44,030
ITE-752075	75/20/75	74.2	31	19.5	14.5	74.2	31	10	104,270
ITE-752575	75/25/75	74.2	31	24.5	16	74.2	31	10	104,270
ITE-753275	75/32/75	74.2	31	31.5	18	74.2	31	10	98,300
ITE-754075	75/40/75	74.2	31	39.4	20.5	74.2	31	10	98,300
ITE-755075	75/50/75	74.2	31	49.4	23.5	74.2	31	10	98,300
ITE-756375	75/63/75	74.2	31	62.5	27.5	74.2	31	10	98,300
ITE-902590	90/25/90	89.2	35.5	24.5	16	89.2	35.5	5	176,940
ITE-903290	90/32/90	89.2	35.5	31.5	18	89.2	35.5	5	176,940
ITE-904090	90/40/90	89.2	35.5	39.4	20.5	89.2	35.5	5	168,520
ITE-905090	90/50/90	89.2	35.5	49.4	23.5	89.2	35.5	5	168,520
ITE-906390	90/63/90	89.2	35.5	62.5	27.5	89.2	35.5	5	168,520
ITE-907590	90/75/90	89.2	35.5	74.2	31	89.2	35.5	5	168,520
ITE-113211	110/32/110	109	41.5	31.5	18	109	41.5	2	281,220
ITE-114011	110/40/110	109	41.5	39.4	20.5	109	41.5	2	281,220
ITE-115011	110/50/110	109	41.5	49.4	23.5	109	41.5	2	266,820
ITE-116311	110/63/110	109	41.5	62.5	27.5	109	41.5	2	266,820
ITE-117511	110/75/110	109	41.5	74.2	31	109	41.5	2	266,820
ITE-119011	110/90/110	109	41.5	89.2	35.5	109	41.5	2	266,820
ITE-121112	125/110/125	123.9	46.5	109	41.5	123.9	46.5	2	526,620

PP-R İNEGAL TE PN 25

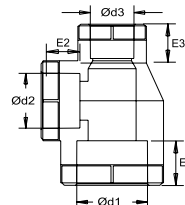

PP-R RADYATÖR BAYPAS PN 25

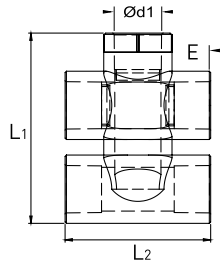

Kod	Ölçü (ø)	Ø d1	E	L1	L2	Miktar	Fiyat ₺
RBS-202000	20/20	19.5	14.5	78.3	60	100	10,740
RBS-252500	25/25	24.5	16	93	70	60	16,200

PP-R İSTAVROZ PN 25

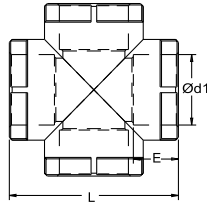

Kod	Ölçü (ø)	Ø d1	E	L	Miktar	Fiyat ₺
IST-200000	20	19.5	14.5	50	200	4,770
IST-250000	25	24.5	16	55	125	6,810
IST-320000	32	31.5	18	60	60	12,810
IST-400000	40	39.4	20.5	86	40	21,530

PP-R İNEĞAL İSTAVROZ PN 25

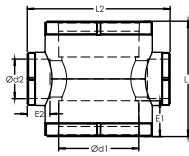

Kod	Ölçü (ø)	Ød1	Ød2	E1	E2	L1	L2	Miktar	Fiyat ₺
IIS-252000	25/20	24.5	19.5	16.0	14.5	56	56	150	7,870
IIS-322500	32/25	31.5	24.5	18	16.0	70	70	75	15,170
IIS-403200	40/32	39.4	31.5	20.5	18	86	86	40	22,470
IIS-502000	50/20	49.4	19.5	23.5	14.5	84	95	30	25,280
IIS-502500	50/25	49.4	24.5	23.5	16	84	95	30	27,390
IIS-503200	50/32	49.4	31.5	23.5	18	114	95	25	29,490
IIS-504000	50/40	49.4	39.4	23.5	20.5	114	95	25	31,600
IIS-632000	63/20	62.5	19.5	27.5	14.5	91	111	16	42,130
IIS-632500	63/25	62.5	24.5	27.5	16	91	111	16	46,340
IIS-633200	63/32	62.5	31.5	27.5	18	127	113	16	50,560
IIS-634000	63/40	62.5	39.4	27.5	20.5	127	113	16	54,770
IIS-635000	63/50	62.5	49.4	27.5	23.5	127	113	12	55,900

PP-R KÖŞE İSTAVROZ PN 25

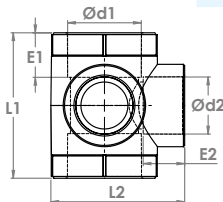

Kod	Ölçü (ø)	Ød1	Ød2	E1	E2	L1	L2	Miktar	Fiyat ₺
KIS-322000	32/20	31.5	19.5	18	14.5	62	57	80	11,670
KIS-322500	32/25	31.5	24.5	18	16	62	57	80	11,670
KIS-402000	40/20	39.4	19.5	20.5	14.5	66	60	60	17,280
KIS-402500	40/25	39.4	24.5	20.5	16	66	60	60	17,280



Kod	Ölçü (ø)	Ø d1	E	Miktar	Fiyat ₺
KPB-200000	20	19.5	14.5	750	1,440
KPB-250000	25	24.5	16	500	2,150
KPB-320000	32	31.5	18	250	3,360
KPB-400000	40	39.4	20.5	150	4,710
KPB-500000	50	49.4	23.5	80	8,720
KPB-630000	63	62.5	27.5	50	16,760
KPB-750000	75	74.2	31	25	29,810
KPB-900000	90	89.2	35.5	18	43,440
KPB-110000	110	109	41.5	9	84,600
KPB-125000	125	123.9	46.5	6	189,100

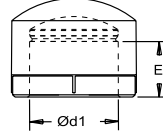

PP-R KAPAMA BAŞLIĞI PN 25



Kod	Ölçü (ø)	Ø d1	Ø d2	E	L	Miktar	Fiyat ₺
FLA-500000	50	49.4	65	23.5	32	80	22,980
FLA-630000	63	62.5	80	27.5	40	50	28,720
FLA-750000	75	74.2	95	31	40	40	53,630
FLA-900000	90	89.2	111	35.5	42	25	66,930
FLA-110000	110	109	132	41.5	49	12	88,180

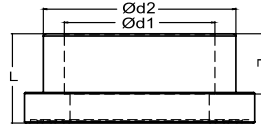

PP-R FLANŞ ADAPTÖRÜ



Kod	Ölçü (ø)	Ø d1	Ø d2	L	Miktar	Fiyat ₺
FLN-500000	50	66	17	109	30	68,940
FLN-630000	63	81	17	121	30	76,600
FLN-750000	75	97	17	144	16	134,150
FLN-900000	90	113	17	160	16	153,190
FLN-110000	110	133	17	180	12	191,500

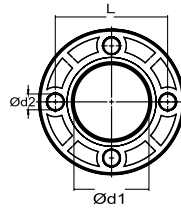

FLANŞ

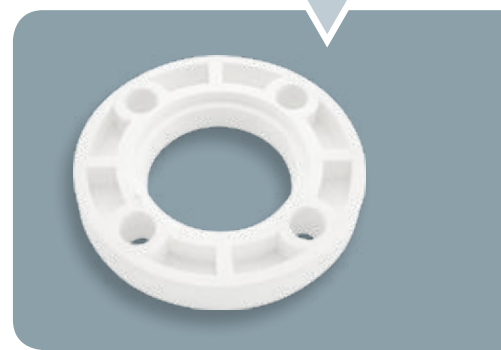

Kod	Ölçü (ø)	d	L	E	Miktar	Fiyat ₺
UKT-200012	20 x 1/2"	20.3	56	5	750	1,730

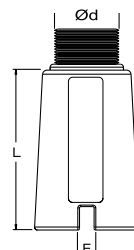

PP-R UZUN KÖRTAPA PN 25



PP-R KÖRTAPA PN 25

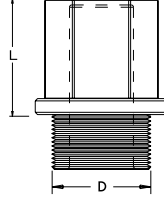

Kod	Ölçü (ø)	D	L	Miktar	Fiyat ₺
KTP-200012	20 x 1/2"	20.3	25	2500	0,860
KTP-250034	25 x 3/4"	26	15	2500	0,970

CETVEL

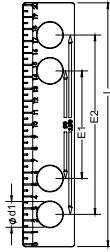

Kod	Ölçü (ø)	Ø d1	E1	E2	L	Miktar	Fiyat ₺
CTV-000000	1/2"	20.5	90	150	200	400	5,940



PP-R ERKEK İSTAVROZ PN 25

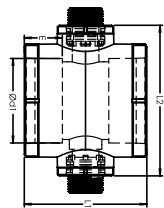

Kod	Ölçü (ø)	Ø d1	E	L1	L2	Miktar	Fiyat ₺
EIM-500012	50 x 1/2"	49.4	23.5	84	95	16	124,040
EIM-500034	50 x 3/4"	49.4	23.5	84	95	16	152,110
EIM-500100	50 x 1"	49.4	23.5	114	95	16	187,220
EIM-500114	50 x 1 1/4"	49.4	23.5	114	95	12	210,630
EIM-630012	63 x 1/2"	62.5	27.5	91	111	8	187,220
EIM-630034	63 x 3/4"	62.5	27.5	91	111	8	210,630
EIM-630100	63 x 1"	62.5	27.5	127	113	8	234,060
EIM-630114	63 x 1 1/4"	62.5	27.5	127	120	6	257,450

PP-R DIŞI İSTAVROZ PN 25

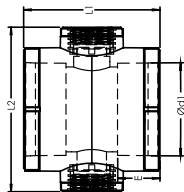

Kod	Ölçü (ø)	Ø d1	E	L1	L2	Miktar	Fiyat ₺
DIM-250012	25 x 1/2"	24.5	16	56	56	80	28,440
DIM-320034	32 x 3/4"	31.5	18	70	70	40	51,570
DIM-400034	40 x 3/4"	39.4	20.5	86	86	20	54,070
DIM-400100	40 x 1"	39.4	20.5	86	86	20	56,880
DIM-500012	50 x 1/2"	49.4	23.5	84	95	16	67,890
DIM-500034	50 x 3/4"	49.4	23.5	84	95	16	79,570
DIM-500100	50 x 1"	49.4	23.5	114	95	16	107,670
DIM-500114	50 x 1 1/4"	49.4	23.5	114	95	12	140,420
DIM-630012	63 x 1/2"	62.5	27.5	91	111	8	79,570
DIM-630034	63 x 3/4"	62.5	27.5	91	111	8	105,320
DIM-630100	63 x 1"	62.5	27.5	127	113	8	124,030
DIM-630114	63 x 1 1/4"	62.5	27.5	127	120	6	163,830

Kod	Ölçü (ø)	Ø d1	E	D	L	Miktar	Fiyat ₺
KBP-200000	20	19.5	14.5	20.3	22	300	10,110
KBP-250000	25	24.5	16	25.3	25	200	13,700
KBP-320000	32	31.5	18	32.3	30	100	28,890

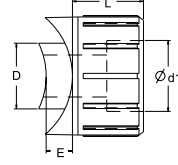
**PP-R PLASTİK BRANŞMAN PN 25**

Kod	Ölçü (ø)	D	E	L	Miktar	Fiyat ₺
EKB-200012	20 x 1/2"	20.3	14.5	40	150	23,600
EKB-250034	25 x 3/4"	25.3	16	42	100	36,870
EKB-320100	32 x 1	32.3	18	44	50	66,360

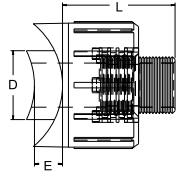
**PP-R ERKEK BRANŞMAN PN 25**

Kod	Ölçü (ø)	D	E	L	Miktar	Fiyat ₺
DKB-200012	20 x 1/2"	20.3	14.5	22	150	18,870
DKB-250034	25 x 3/4"	25.3	16	25	100	25,570
DKB-320100	32 x 1	32.3	18	30	50	53,940

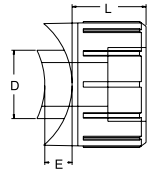
**PP-R DIŞI BRANŞMAN PN 25**

Kod	Ölçü (ø)	Ø d1	E	L	Miktar	Fiyat ₺
ENP-200012	20 x 1/2"	19.5	14.5	55	150	15,100
ENP-200034	20 x 3/4"	19.5	14.5	55	100	25,050
ENP-250012	25 x 1/2"	24.5	16	57	125	18,560
ENP-250034	25 x 3/4"	24.5	16	57	80	24,240
ENP-250100	25 x 1"	24.5	16	57	50	51,190
ENP-320012	32 x 1/2"	31.5	18	60	50	37,920
ENP-320034	32 x 3/4"	31.5	18	60	60	36,510
ENP-320100	32 x 1"	31.5	18	60	60	47,390

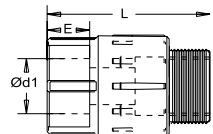
**PP-R ERKEK NİPEL PN 25**

PP-R ALTIKÖŞE ERKEK NİPEL PN 25

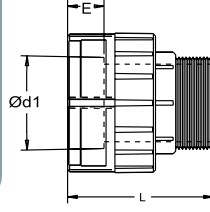

Kod	Ölçü (ø)	Ø d1	E	L	Miktar	Fiyat ₺
AEN-320100	32 x 1"	31.5	18	59	50	57,250
AEN-400100	40 x 1"	39.4	20.5	75	20	84,260
AEN-400114	40 x 1 1/4"	39.4	20.5	80	20	95,120
AEN-500112	50 x 1 1/2"	49.4	23.5	90	15	129,890
AEN-630200	63 x 2"	62.5	27.5	95	10	216,050
AEN-750212	75 x 2 1/2"	74.2	31	105	6	324,950
AEN-900300	90 x 3"	89.2	35.5	120	4	516,530
AEN-110400	110 x 4"	109	41.5	130	2	921,880
AEN-125500	125 x 5"	123.9	46.5	140	2	1.441,880

PP-R DIŞİ NİPEL PN 25

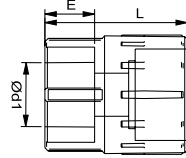

Kod	Ölçü (ø)	Ø d1	E	L	Miktar	Fiyat ₺
DNP-200012	20 x 1/2"	19.5	14.5	40	150	12,950
DNP-200034	20 x 3/4"	19.5	14.5	40	125	18,430
DNP-250012	25 x 1/2"	24.5	16	42	125	13,830
DNP-250034	25 x 3/4"	24.5	16	42	100	17,890
DNP-250100	25 x 1"	24.5	16	42	50	41,600
DNP-320012	32 x 1/2"	31.5	18	44	75	28,090
DNP-320034	32 x 3/4"	31.5	18	44	50	28,090
DNP-320100	32 x 1"	31.5	18	44	75	38,530

**30 yıldır 5 kıtada 80 ülkede,
profesyonellerin ilk tercihi**



snowdrop
serisi



Kod	Ölçü (ø)	Ø d1	E	L	Miktar	Fiyat ₺
ADN-320100	32 x 1"	31.5	18	55	40	45,910
ADN-400100	40 x 1"	39.4	20.5	60	20	70,220
ADN-400114	40 x 1 1/4"	39.4	20.5	65	20	72,650
ADN-500112	50 x 1 1/2"	49.4	23.5	70	20	92,380
ADN-630200	63 x 2"	62.5	27.5	75	10	172,420
ADN-750212	75 x 2 1/2"	74.2	31	80	8	287,300
ADN-900300	90 x 3"	89.2	35.5	105	6	411,620
ADN-110400	110 x 4"	109	41.5	110	2	697,620
ADN-125500	125 x 5"	123.9	46.5	130	2	1.233,350

PP-R ALTİKÖŞE DİŞİ NİPEL PN 25

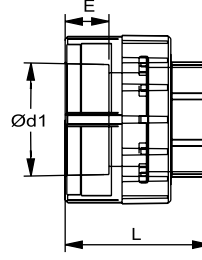

Kod	Ölçü (ø)	Ø d1	E	L	Miktar	Fiyat ₺
EDR-200012	20 x 1/2"	19.5	14.5	35	100	15,800
EDR-200034	20 x 3/4"	19.5	14.5	35	75	25,620
EDR-250012	25 x 1/2"	24.5	16	40	100	20,590
EDR-250034	25 x 3/4"	24.5	16	40	75	24,500
EDR-320012	32 x 1/2"	31.5	18	45	30	31,990
EDR-320034	32 x 3/4"	31.5	18	45	30	37,920
EDR-320100	32 x 1"	31.5	18	45	30	51,370

PP-R ERKEK DİRSEK PN 25

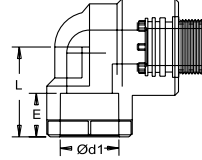

Kod	Ölçü (ø)	Ø d1	E	L	Miktar	Fiyat ₺
AED-320100	32 x 1"	31.5	18	38.5	30	62,650
AED-400114	40 x 1 1/4"	39.4	20.5	48.5	20	113,230
AED-500112	50 x 1 1/2"	49.4	23.5	59	10	197,240
AED-630200	63 x 2"	62.5	27.5	76.5	6	333,060

PP-R ALTİKÖŞE ERKEK DİRSEK PN 25

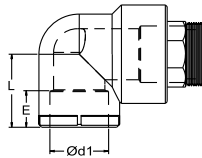

Kod	Ölçü (ø)	Ø d1	E	L	Miktar	Fiyat ₺
DDR-200012	20 x 1/2"	19.5	14.5	35	125	13,500
DDR-200034	20 x 3/4"	19.5	14.5	35	80	19,400
DDR-250012	25 x 1/2"	24.5	16	40	125	15,200
DDR-250034	25 x 3/4"	24.5	16	40	80	18,200
DDR-320012	32 x 1/2"	31.5	18	45	30	24,810
DDR-320034	32 x 3/4"	31.5	18	45	30	28,090
DDR-320100	32 x 1"	31.5	18	45	30	40,730

PP-R DİŞİ DİRSEK PN 25

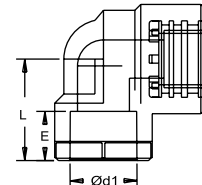

PP-R ALTİKÖŞE DİŞİ DİRSEK PN 25

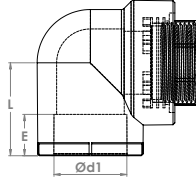

Kod	Ölçü (ø)	Ø d1	E	L	Miktar	Fiyat ₺
ADD-320100	32 x 1"	31.5	18	38.5	30	47,530
ADD-400114	40 x 1 1/4"	39.4	20.5	48.5	20	88,320
ADD-500112	50 x 1 1/2"	49.4	23.5	59	12	157,810
ADD-630200	63 x 2"	62.5	27.5	76.5	8	242,870

PP-R ERKEK BATARYA 3 AYAK PN 25

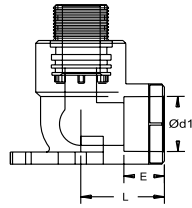

Kod	Ölçü (ø)	Ø d1	E	L	Miktar	Fiyat ₺
3EB-200012	20 x 1/2"	19.5	14.5	30	60	18,060
3EB-250012	25 x 1/2"	24.5	16	33	50	21,060

PP-R DİŞİ BATARYA 3 AYAK PN 25

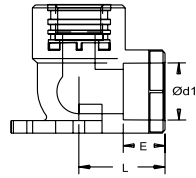

Kod	Ölçü (ø)	Ø d1	E	L	Miktar	Fiyat ₺
3DB-200012	20 x 1/2"	19.5	14.5	30	75	15,500
3DB-250012	25 x 1/2"	24.5	16	33	60	18,750

PP-R DİŞİ BATARYA 2 AYAK PN 25

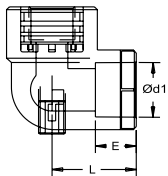

Kod	Ölçü (ø)	Ø d1	E	L	Miktar	Fiyat ₺
2DB-250034	25 x 3/4"	24.5	16	40	60	24,230

PP-R ASKILI BATARYA PN 25

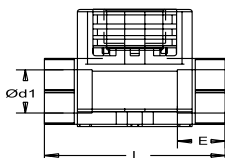

Kod	Ölçü (ø)	Ø d1	E	L	Miktar	Fiyat ₺
GBT-200012	20 x 1/2"	19.5	14.5	60	50	17,900



Kod	Ölçü (ø)	Ø d1	E	L	Miktar	Fiyat ₺
ECB-200012	20 x 1/2"	19.5	14.5	150	20	58,860
ECB-200034	20 x 3/4"	19.5	14.5	150	20	87,420
ECB-250012	25 x 1/2"	24.5	16	150	20	66,230
ECB-250034	25 x 3/4"	24.5	16	150	20	77,500

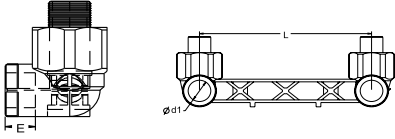

Kod	Ölçü (ø)	Ø d1	E	L	Miktar	Fiyat ₺
CBT-200012	20 x 1/2"	19.5	14.5	150	25	43,200
CBT-250012	25 x 1/2"	24.5	16	150	20	57,500

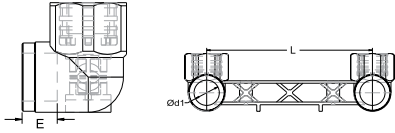

PP-R ERKEK ÇİFTLİ BATARYA BAĞLANTISI PN 25

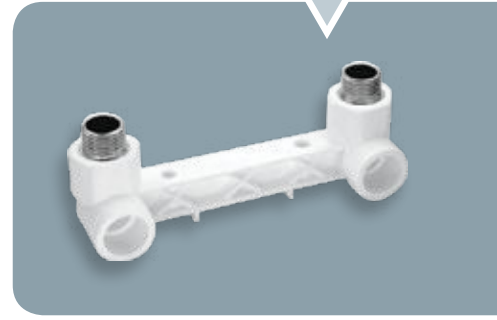

PP-R DIŞİ ÇİFTLİ BATARYA BAĞLANTISI PN 25

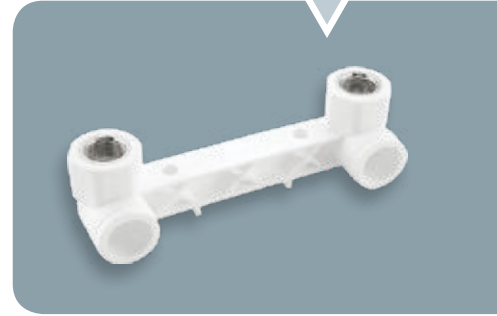

PP-R ERKEK ÇİFTLİ BATARYA BAĞLANTISI PN 25-LEVHA TİP

Kod	Ölçü (ø)	Ø d1	E	L	Miktar	Fiyat ₺
EBU-200012	20 x 1/2"	19.5	14.5	150	20	58,860
EBU-200034	20 x 3/4"	19.5	14.5	150	20	87,420
EBU-250012	25 x 1/2"	24.5	16	150	20	66,230
EBU-250034	25 x 3/4"	24.5	16	150	20	77,500

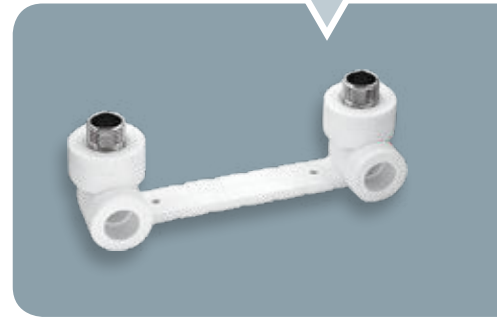
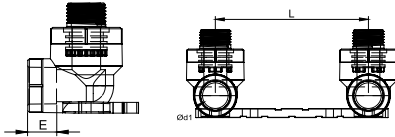

PP-R DIŞİ ÇİFTLİ BATARYA BAĞLANTISI PN 25-LEVHA TİP

Kod	Ölçü (ø)	Ø d1	E	L	Miktar	Fiyat ₺
DBU-200012	20 x 1/2"	19.5	14.5	150	25	43,200
DBU-200034	20 x 3/4"	19.5	14.5	150	25	67,760
DBU-250012	25 x 1/2"	24.5	16	150	20	57,500
DBU-250034	25 x 3/4"	24.5	16	150	20	65,200

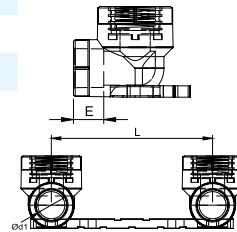

PP-R AYARLI BATARYA PN 25

Kod	Ölçü (ø)	Ø d1	E	L1	L2	L3	Miktar	Fiyat ₺
ABT-200012	20 x 1/2"	19.5	14.5	105	135	150	15	47,810
ABT-250012	25 x 1/2"	24.5	16	105	135	150	15	65,140

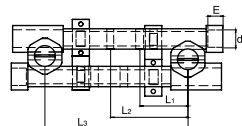

PP-R ERKEK TAHARET BAĞLANTISI PN 25 - ÇİFT GİRİŞ



Kod	Ölçü (ø)	Ø d1	E	L	Miktar	Fiyat ₺
EBK-200012	20 x 1/2"	19.5	14.5	100	30	56,170
EBK-200034	20 x 3/4"	19.5	14.5	100	30	83,840
EBK-250012	25 x 1/2"	24.5	16	100	25	62,780
EBK-250034	25 x 3/4"	24.5	16	100	25	74,150

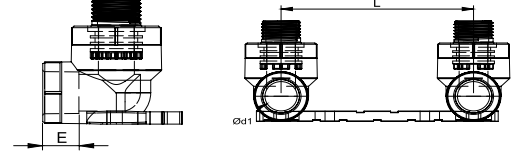

PP-R DIŞI TAHARET BAĞLANTISI PN 25 - ÇİFT GİRİŞ



Kod	Ölçü (ø)	Ø d1	E	L	Miktar	Fiyat ₺
DBK-200012	20 x 1/2"	19.5	14.5	100	30	36,740
DBK-250012	25 x 1/2"	24.5	16	100	25	45,630
DBK-250034	25 x 3/4"	24.5	16	100	25	58,980

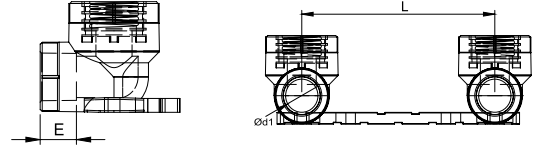

PP-R ERKEK TAHARET BAĞLANTISI PN 25



Kod	Ölçü (ø)	Ø d1	E	L	Miktar	Fiyat ₺
ETB-200012	20 x 1/2"	19.5	14.5	90	30	56,170
ETB-250012	25 x 1/2"	24.5	16	90	25	62,780

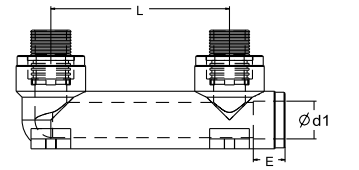

PP-R DIŞI TAHARET BAĞLANTISI PN 25



Kod	Ölçü (ø)	Ø d1	E	L	Miktar	Fiyat ₺
DTB-200012	20 x 1/2"	19.5	14.5	90	35	36,740
DTB-250012	25 x 1/2"	24.5	16	90	25	45,630

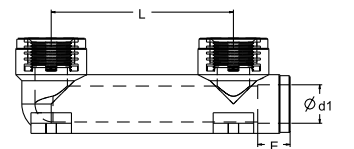

PP-R ERKEK TE PN 25

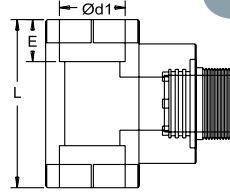

Kod	Ölçü (ø)	Ø d1	E	L	Miktar	Fiyat ₺
ETE-200012	20 x 1/2"	19.5	14.5	52	100	18,580
ETE-200034	20 x 3/4"	19.5	14.5	52	75	26,080
ETE-250012	25 x 1/2"	24.5	16	59	75	20,730
ETE-250034	25 x 3/4"	24.5	16	59	50	26,360
ETE-320012	32 x 1/2"	31.5	18	70	30	49,490
ETE-320034	32 x 3/4"	31.5	18	44	30	50,510
ETE-320100	32 x 1"	31.5	18	44	30	62,240
ETE-400012	40 x 1/2"	39.4	20.5	77	20	100,940
ETE-400034	40 x 3/4"	39.4	20.5	77	20	121,130
ETE-400100	40 x 1"	39.4	20.5	82	20	141,310
ETE-500012	50 x 1/2"	49.4	23.5	87	15	121,130
ETE-500034	50 x 3/4"	49.4	23.5	87	15	141,310
ETE-500100	50 x 1"	49.4	23.5	102	15	181,680
ETE-630012	63 x 1/2"	62.5	27.5	120	8	181,680
ETE-630034	63 x 3/4"	62.5	27.5	120	8	201,870
ETE-630100	63 x 1"	62.5	27.5	120	8	222,050

PP-R ALTİKÖŞE ERKEK TE PN 25

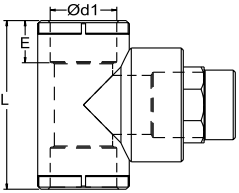

Kod	Ölçü (ø)	Ø d1	E	L	Miktar	Fiyat ₺
EAT-320100	32 x 1"	31.5	18	70	30	84,260
EAT-400114	40 x 1 1/4"	39.4	20.5	97.5	15	137,620

PP-R DIŞİ TE PN 25

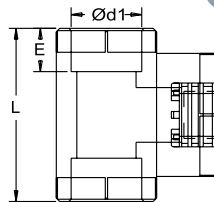

Kod	Ölçü (ø)	Ø d1	E	L	Miktar	Fiyat ₺
DTE-200012	20 x 1/2"	19.5	14.5	60	100	13,500
DTE-200034	20 x 3/4"	19.5	14.5	60	75	21,640
DTE-250012	25 x 1/2"	24.5	16	52	75	15,710
DTE-250034	25 x 3/4"	24.5	16	66	50	19,000
DTE-320012	32 x 1/2"	31.5	18	80	30	29,090
DTE-320034	32 x 3/4"	31.5	18	80	30	34,010
DTE-320100	32 x 1"	31.5	18	80	30	37,920
DTE-400012	40 x 1/2"	39.4	20.5	77	20	70,220
DTE-400034	40 x 3/4"	39.4	20.5	77	20	87,780
DTE-400100	40 x 1"	39.4	20.5	82	20	105,320
DTE-500012	50 x 1/2"	49.4	23.5	87	15	69,520
DTE-500034	50 x 3/4"	49.4	23.5	87	15	73,730
DTE-500100	50 x 1"	49.4	23.5	102	15	126,390
DTE-630012	63 x 1/2"	62.5	27.5	120	9	73,730
DTE-630034	63 x 3/4"	62.5	27.5	120	9	96,900
DTE-630100	63 x 1"	62.5	27.5	120	9	164,310

PP-R ALTIKÖŞE DIŞI TE PN 25

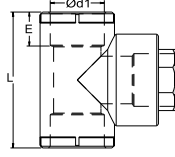

Kod	Ölçü (ø)	Ø d1	E	L	Miktar	Fiyat ₺
DAT-320100	32 x 1"	31.5	18	80	30	54,660
DAT-400114	40 x 1 1/4"	39.4	20.5	97.5	20	109,750

PP-R PLASTİK KÜRESEL VANA PN 25

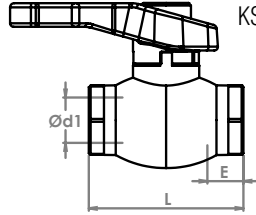

Kod	Ölçü (ø)	Ø d1	E	L	Miktar	Fiyat ₺
KSV-200012	20	19.5	14.5	66	50	29,500
KSV-250034	25	24.5	16	73	40	42,130
KSV-320100	32	31.5	18	88	20	84,240
KSV-400114	40	39.4	20.5	105	12	139,030
KSV-500112	50	49.4	23.5	125	8	231,710
KSV-630200	63	62.5	27.5	150	4	393,920
KSV-750212	75	74.2	31	165	4	509,770

PP-R PLASTİK KÜRESEL VANA PN 25 - EKO

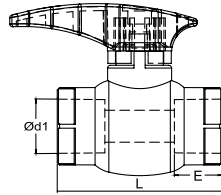

Kod	Ölçü (ø)	Ø d1	E	L	Miktar	Fiyat ₺
KVE-200000	20	19.5	14.5	59	90	25,280
KVE-250000	25	24.5	16	64	60	35,820
KVE-320000	32	31.5	18	75	40	54,780

PP-R PLASTİK KÜRESEL VANA PN 25 - EKO

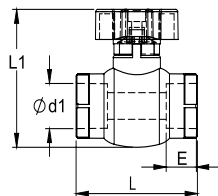

Kod	Ölçü (ø)	Ø d1	E	L	L1	Miktar	Fiyat ₺
KVE-200000-K	20	19.5	14.5	59	60	90	25,280
KVE-250000-K	25	24.5	16	64	65	60	35,820
KVE-320000-K	32	31.5	18	75	70	40	54,780

Kod	Ölçü (ø)	Ø d1	E	L	L1	Miktar	Fiyat ₺
SKV-200000	20	19,5	14,5	70	98	24	51,400
SKV-250000	25	24,5	16	75	102	20	72,300

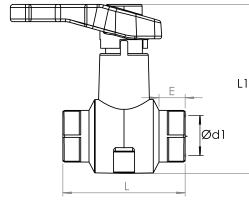

YENİ ÜRÜN

KÜRESEL VANA - SIVA ALTI



Kod	Ölçü (ø)	Ø d1	E	L	Miktar	Fiyat ₺
COK-200000	20	19,5	14,5	120	30	106,590
COK-250000	25	24,5	16	124	20	157,560
COK-320000	32	31,5	18	140	15	231,710

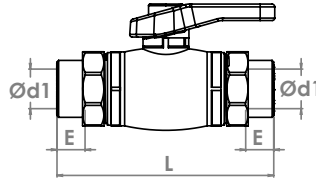

PP-R KÜRESEL VANA PN 25 - ÇİFT TARAFLI



Kod	Ölçü (ø)	Ø d1	E	L	Miktar	Fiyat ₺
DTV-200000	20 x 1/2"	19,5	14,5	91	30	92,690
DTV-250000	25 x 3/4"	24,5	16	95	25	134,400
DTV-320000	32 x 1"	31,5	18	109	20	199,270

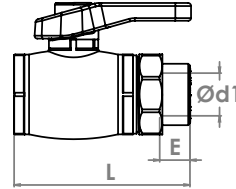

PP-R DIŞI KÜRESEL VANA PN 25 - TEK TARAFLI



Kod	Ölçü (ø)	Ø d1	E	L	Miktar	Fiyat ₺
TOK-200000	20	19,5	14,5	91	30	83,410
TOK-250000	25	24,5	16	95	25	111,220
TOK-320000	32	31,5	18	109	20	162,210

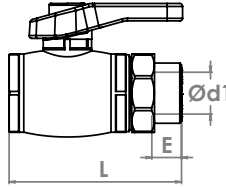

PP-R KÜRESEL VANA PN 25 - TEK TARAFLI



Kod	Ölçü (ø)	Ø d1	E	L	Miktar	Fiyat ₺
DKV-200012	20 x 1/2"	19,5	14,5	64	50	64,880
DKV-250034	25 x 3/4"	24,5	16	67	40	92,690
DKV-320100	32 x 1"	31,5	18	78	20	148,300

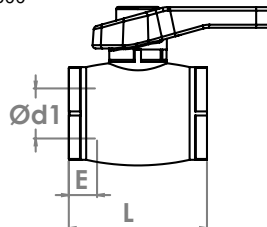

PP-R DIŞI KÜRESEL VANA PN 25



PP-R KOLLEKTÖR VANASI PN 25



YENİ ÜRÜN

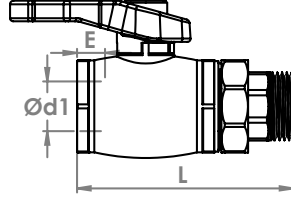

Kod	Ölçü (ø)	Ø d1	E	L	Miktar	Fiyat ₺
KTV-250100	25 x 1"	24.5	16	106	25	145,500
KTV-320100	32 x 1"	31.5	18	110	25	145,500

PP-R RADYATÖR VANASI PN 25 - DÜZ

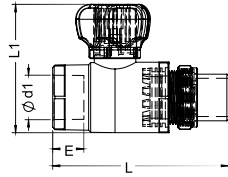

Kod	Ölçü (ø)	Ø d1	E	L	L1	Miktar	Fiyat ₺
KRN-200012	20 x 1/2"	19.5	14.5	89	67	50	58,970
KRN-250012	25 x 1/2"	24.5	16	89	67	50	67,410
KRN-250034	25 x 3/4"	24.5	16	94	72	40	84,240

PP-R RADYATÖR VANASI PN 25 - DİRSEKLİ

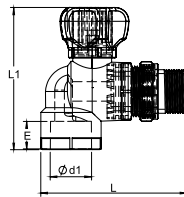

Kod	Ölçü (ø)	Ø d1	E	L	L1	Miktar	Fiyat ₺
KRD-200012	20 x 1/2"	19.5	14.5	87.5	83	50	58,970
KRD-250012	25 x 1/2"	24.5	16	87.5	83	50	67,410
KRD-250034	25 x 3/4"	24.5	16	91	90.5	40	84,240

PP-R OYNAR BAŞLI RADYATÖR NİPELİ PN 25

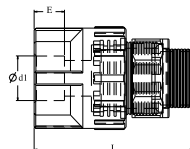

Kod	Ölçü (ø)	Ø d1	E	L	Miktar	Fiyat ₺
ORN-200012	20 x 1/2"	19.5	14.5	55	60	38,630
ORN-200034	20 x 3/4"	19.5	14.5	57	50	63,190
ORN-250012	25 x 1/2"	24.5	16	57	60	45,650
ORN-250034	25 x 3/4"	24.5	16	57	50	59,690



PP-R OYNAR BAŞLI RADYATÖR DİRSEĞİ PN 25

Kod	Ölçü (ø)	Ø d1	E	L	Miktar	Fiyat ₺
ORD-200012	20 x 1/2"	19.5	14.5	30	60	38,630
ORD-200034	20 x 3/4"	19.5	14.5	35	50	63,190
ORD-250012	25 x 1/2"	24.5	16	40	60	45,650
ORD-250034	25 x 3/4"	24.5	16	40	50	59,690

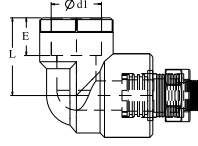

PP-R KELEBEK VANA PN 25

Kod	Ölçü (ø)	Ø d1	L	L1	E	Miktar	Fiyat ₺
KBV-200012	20	19.5	73	96	14.5	40	49,910
KBV-250034	25	24.5	73	105	16	30	56,710
KBV-320100	32	31.5	86	109	18	20	102,080
KBV-400114	40	39.4	93	129	20.5	15	127,610

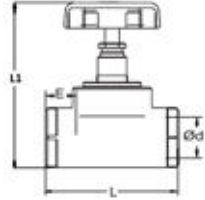

PP-R LÜX STOP VANA PN 25

Kod	Ölçü (ø)	Ø d1	E	L	L1	Miktar	Fiyat ₺
LSV-200000	20	19.5	14.5	73	138	15	88,970
LSV-250000	25	24.5	16	78	138	15	95,290
LSV-320000	32	31.5	18	87	143	15	102,160

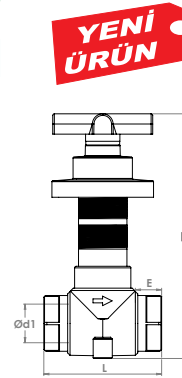

PP-R KROMLU ANKASTRE VANA PN 25

Kod	Ölçü (ø)	Ø d1	E	L	L1	Miktar	Fiyat ₺
KAV-200012	20	19.5	14.5	73	93	30	132,070
KAV-250034	25	24.5	16	73	94	25	154,320
KAV-320100	32	31.5	18	86	105	25	197,810
KAV-400114	40	39.4	20.5	93	107	20	219,270

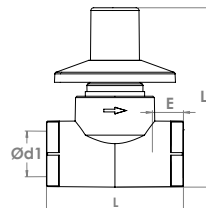

PP-R KROMLU VANA PN 25

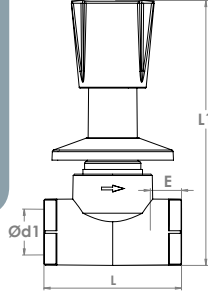

Kod	Ölçü (ø)	Ø d1	E	L	L1	Miktar	Fiyat ₺
KVZ-200012	20	19.5	14.5	73	138	25	158,610
KVZ-250034	25	24.5	16	73	141	20	176,400
KVZ-320100	32	31.5	18	86	151	15	232,500
KVZ-400114	40	39.4	20.5	93	157	10	252,580

PP-R KROMLU VANA PN 25 - MEVLANA

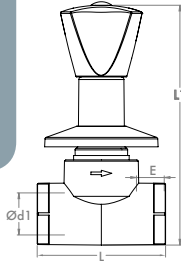

Kod	Ölçü (ø)	Ø d1	E	L	L1	Miktar	Fiyat ₺
KVZ-200012-M	20	19.5	14.5	73	131	25	158,610
KVZ-250034-M	25	24.5	16	73	137	20	176,400
KVZ-320100-M	32	31.5	18	86	147	15	232,500
KVZ-400114-M	40	39.4	20.5	93	153	10	252,580

PP-R KROMLU KÜRESEL VANA PN 25

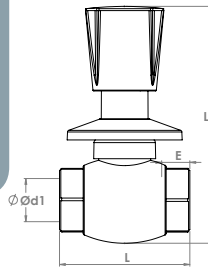

Kod	Ölçü (ø)	Ø d1	E	L	L1	Miktar	Fiyat ₺
KKV-200012	20	19.5	14.5	67	132	25	120,280
KKV-250034	25	24.5	16	74	138	20	150,400
KKV-320100	32	31.5	18	87	150	15	180,520

PP-R KROMLU KÜRESEL VANA PN 25 - MEVLANA

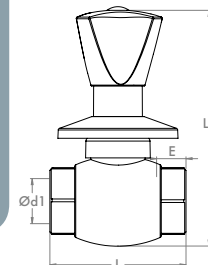

Kod	Ölçü (ø)	Ø d1	E	L	L1	Miktar	Fiyat ₺
KKV-200012-M	20	19.5	14.5	67	126	25	120,280
KKV-250034-M	25	24.5	16	74	133	20	150,400
KKV-320100-M	32	31.5	18	87	148	15	180,520

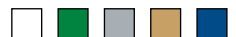

PP-R BAHÇE MUSLUĞU

Kod	Ölçü (R)	Ø d1	L	L1	Miktar	Fiyat ₺
BMS-200012	1/2"	13,6	74	63	40	47,610

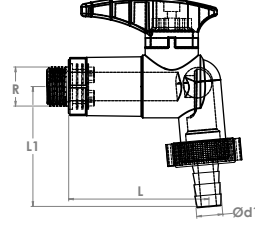
**PP-R ÇAMAŞIR MAKİNESİ MUSLUĞU**

Kod	Ölçü (R-R2)	L	L1	Miktar	Fiyat ₺
CMS-200000	1/2-3/4"	72	39	40	41,360

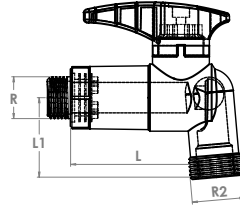
**ÇİFTLİ MUSLUK ÇATALI**

Kod	Ölçü (R)	Miktar	Fiyat ₺
MCT-000034	3/4"	100	15,900

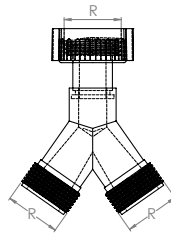
**PP-R ERKEK ÇEKVALF PN 25**

Kod	Ölçü (ø)	Ø d1	Ø d2	E	L	Miktar	Fiyat ₺
VEF-200012	20	19.5	20.3	14.5	67	75	25,280
VEF-250034	25	24.5	25.3	16	71	50	31,600
VEF-320100	32	31.5	32.3	18	100	25	42,130

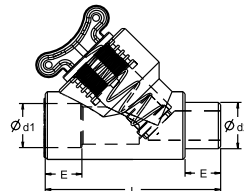

PP-R DIŞI ÇEKVALF PN 25

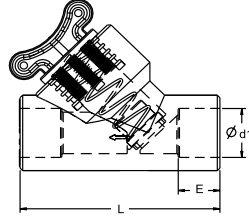

Kod	Ölçü (ø)	Ø d1	E	L	Miktar	Fiyat ₺
VDF-200012	20	19.5	14.5	67	75	25,280
VDF-250034	25	24.5	16	71	50	31,600
VDF-320100	32	31.5	18	100	25	42,130

PP-R ERKEK VANA PN 25

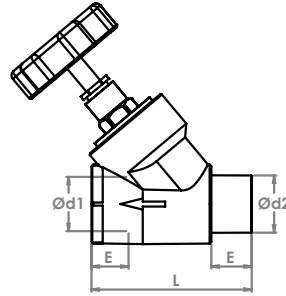

Kod	Ölçü (ø)	Ø d1	Ø d2	E	L	Miktar	Fiyat ₺
DDV-200012	20	19.5	20.3	14.5	78	30	70,020
DDV-250034	25	24.5	25.3	16	88	30	81,730
DDV-320100	32	31.5	32.3	18	106	15	139,030

PP-R DIŞI VANA PN 25

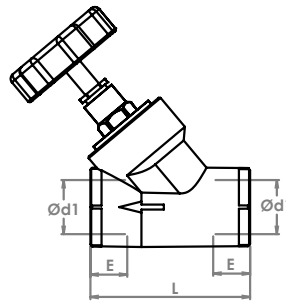

Kod	Ölçü (ø)	Ø d1	E	L	Miktar	Fiyat ₺
IDV-200012	20	19.5	14.5	78	30	70,020
IDV-250034	25	24.5	16	88	30	81,730
IDV-320100	32	31.5	18	106	15	139,030

PP-R ERKEK FİLTRE PN 25

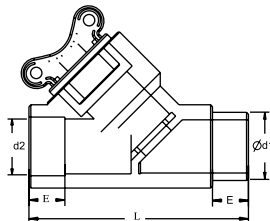

Kod	Ölçü (ø)	Ø d1	Ø d2	E	L	Miktar	Fiyat ₺
EFT-200012	20	20.3	19.5	14.5	78	75	24,660
EFT-250034	25	25.3	24.5	16	88	50	38,530
EFT-320100	32	32.3	31.5	18	106	25	62,500



Kod	Ölçü (ø)	Ø d1	E	L	Miktar	Fiyat ₺
DFT-200012	20	19.5	14.5	78	75	24,660
DFT-250034	25	24.5	16	88	50	38,530
DFT-320100	32	31.5	18	106	25	62,500

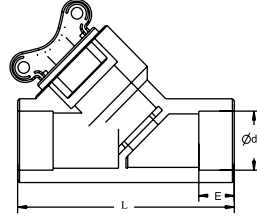

PP-R DIŞI FİLTRE PN 25



Kod	Ölçü (ø)	Ø d1	E	L	Miktar	Fiyat ₺
ENK-200012	20 x 1/2"	20.3	14.5	52	125	18,530
ENK-200034	20 x 3/4"	20.3	14.5	54	100	31,280
ENK-250012	25 x 1/2"	25.3	16	52	125	22,010
ENK-250034	25 x 3/4"	25.3	16	54	75	28,970

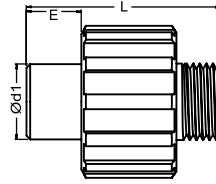

PP-R KUYRUKLU ERKEK NİPEL PN 25



Kod	Ölçü (ø)	Ø d1	E	L	Miktar	Fiyat ₺
DNK-200012	20 x 1/2"	20.3	14.5	41	150	14,830
DNK-200034	20 x 3/4"	20.3	14.5	41	150	21,640
DNK-250012	25 x 1/2"	25.3	16	41	150	17,010
DNK-250034	25 x 3/4"	25.3	16	41	150	20,080

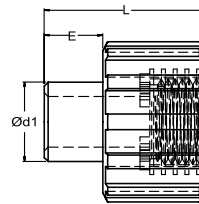

PP-R KUYRUKLU DIŞI NİPEL PN 25



Kod	Ölçü (ø)	Ø d1	E	Miktar	Fiyat ₺
HNP-200012	20 x 1/2"	19.5	14.5	175	33,490
HNP-200034	20 x 3/4"	19.5	14.5	125	37,750
HNP-250012	25 x 1/2"	24.5	16	125	36,020
HNP-250034	25 x 3/4"	24.5	16	125	45,390
HNP-250100	25 x 1"	24.5	16	80	66,820
HNP-320034	32 x 3/4"	31.5	18	75	45,930
HNP-320100	32 x 1"	31.5	18	60	73,940
HNP-320114	32 x 1 1/4"	31.5	18	50	98,300

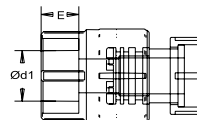

PP-R HAREKETLİ NİPEL PN 25



PP-R HAREKETLİ DİRSEK PN 25

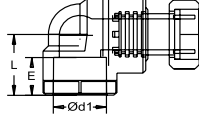

Kod	Ölçü (ø)	Ø d1	E	L	Miktar	Fiyat ₺
HDR-200012	20 x 1/2"	19.5	14.5	30	120	38,800
HDR-200034	20 x 3/4"	19.5	14.5	30	80	39,860
HDR-250034	25 x 3/4"	24.5	16	32	80	49,370
HDR-250100	25 x 1"	24.5	16	32	75	68,920
HDR-320034	32 x 3/4"	31.5	18	38	50	47,390
HDR-320100	32 x 1"	31.5	18	38	50	94,480
HDR-320114	32 x 1"1/4"	31.5	18	38	40	98,300

PP-R HAREKETLİ TE PN 25

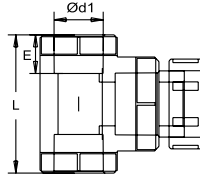

Kod	Ölçü (ø)	Ø d1	E	L	Miktar	Fiyat ₺
HTE-200012	20 x 1/2"	19.5	14.5	30	125	44,650
HTE-200034	20 x 3/4"	19.5	14.5	30	80	39,860
HTE-250034	25 x 3/4"	24.5	16	32	80	52,070
HTE-250100	25 x 1"	24.5	16	32	40	68,920
HTE-320100	32 x 1"	31.5	18	38	30	93,180
HTE-320114	32 x 1"1/4"	31.5	18	38	30	98,300

PP-R PE-X NİPELİ PN 25 - KUYRUKLU

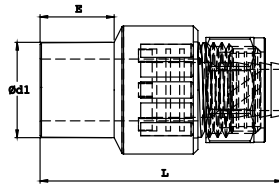

Kod	Ölçü (ø)	Ø d1	E	L	Miktar	Fiyat ₺
SPK-201216	20x1/2x16	20.3	14.5	54	200	37,040

PP-R OYNAR BAŞLI ERKEK RAKOR PN 25

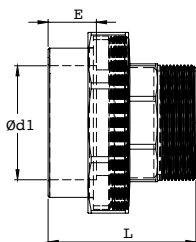

Kod	Ölçü (ø)	Ø d1	E	L	Miktar	Fiyat ₺
MOE-200012	20 x 1/2"	19.5	14.5	45	175	28,630
MOE-200034	20 x 3/4"	19.5	14.5	45	150	33,700
MOE-200100	20 x 1"	19.5	14.5	50	160	54,770
MOE-250012	25 x 1/2"	24.5	16	46	120	42,130
MOE-250034	25 x 3/4"	24.5	16	49	100	44,440
MOE-250100	25 x 1"	24.5	16	50	100	48,300
MOE-320012	32 x 1/2"	31.5	18	49	80	57,300
MOE-320034	32 x 3/4"	31.5	18	49	80	50,560
MOE-320100	32 x 1"	31.5	18	52	75	61,700
MOE-320114	32 x 1"1/4"	31.5	18	56	60	92,690
MOE-400114	40 x 1"1/4"	39.4	20.5	59	40	102,160
MOE-500112	50 x 1"1/2"	49.4	23.5	62	25	190,080
MOE-630200	63 x 2"	62.5	27.5	72	16	359,370
MOE-750212	75 x 2"1/2"	74.2	31	97	6	671,760
MOE-900300	90 x 3"	89.2	35.5	117	3	1,251,230
MOE-110400	110 x 4"	109	41.5	134	2	1,878,090

PP-R PE-X NİPELİ PN 25 - DIŞI

Kod	Ölçü (ø)	Ø d1	E	L	Miktar	Fiyat ₺
SPD-201216	20x1/2x16	19.5	14.5	54	200	37,040

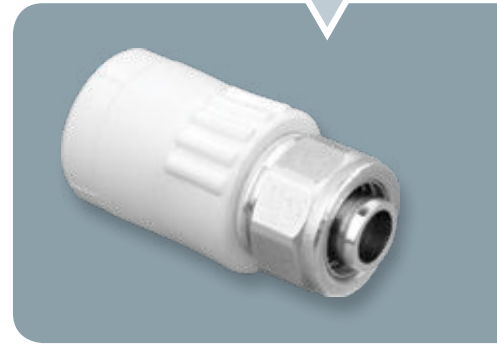
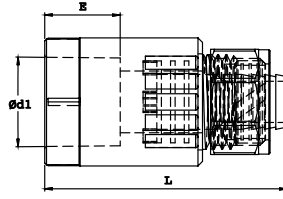

PP-R OYNAR BAŞLI DIŞI RAKOR PN 25

Kod	Ölçü (ø)	Ø d1	E	L	Miktar	Fiyat ₺
MOD-200012	20 x 1/2"	19.5	14.5	38	200	26,760
MOD-200034	20 x 3/4"	19.5	14.5	38	175	29,490
MOD-200100	20 x 1"	19.5	14.5	39	175	46,340
MOD-250012	25 x 1/2"	24.5	16	37	125	37,920
MOD-250034	25 x 3/4"	24.5	16	38	125	38,830
MOD-250100	25 x 1"	24.5	16	40	100	46,340
MOD-320012	32 x 1/2"	31.5	18	42	90	48,460
MOD-320034	32 x 3/4"	31.5	18	42	80	46,340
MOD-320100	32 x 1"	31.5	18	42	80	50,940
MOD-320114	32 x 1 1/4"	31.5	18	46	70	84,260
MOD-400114	40 x 1 1/4"	39.4	20.5	48	50	91,710
MOD-500112	50 x 1 1/2"	49.4	23.5	48	25	150,650
MOD-630200	63 x 2"	62.5	27.5	58	16	314,070
MOD-750212	75 x 2 1/2"	74.2	31	72	9	618,520
MOD-900300	90 x 3"	89.2	35.5	78	6	1.133,490
MOD-110400	110 x 4"	109	41.5	89	2	1.699,070

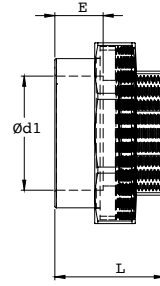

PP-R HAREKETLİ ERKEK NİPEL PN 25 - HAFİF TİP

Kod	Ölçü (ø)	Ø d1	L	Miktar	Fiyat ₺
ONE-200034	20 x 3/4"	20.3	38	200	28,090
ONE-250100	25 x 1"	25.3	43	150	33,700

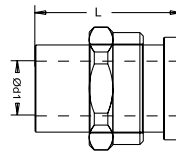

PP-R HAREKETLİ DIŞI NİPEL PN 25 - HAFİF TİP

Kod	Ölçü (ø)	Ø d1	L	Miktar	Fiyat ₺
OND-200034	20 x 3/4"	20.3	38	200	25,280
OND-250100	25 x 1"	25.3	43	150	30,900

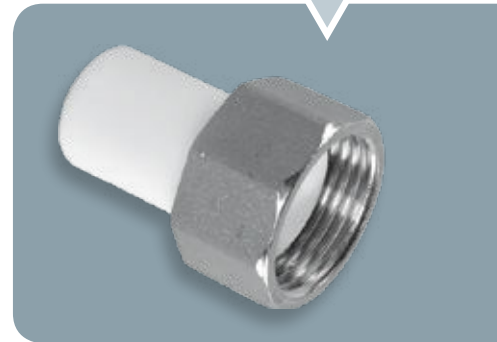
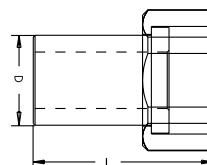

PP-R SU SAYAÇ NİPELİ PN 25

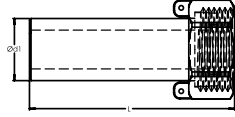

Kod	Ölçü (ø)	Ø d1	L1	Miktar	Fiyat ₺
SSB-200034	20 x 3/4"	20.3	68	175	21,870
SSB-250100	25 x 1"	25.3	68	150	23,400

PP-R ÇİFT TARAFLI KAYNAKLI RAKOR PN 25

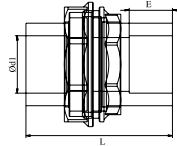

Kod	Ölçü (ø)	Ø d1	E	L	Miktar	Fiyat ₺
MCR-200000	20	19.5	14.5	56	100	43,530
MCR-250000	25	24.5	16	59	75	64,600
MCR-320000	32	31.5	18	60	50	80,050
MCR-400000	40	39.4	20.5	59	30	168,520
MCR-500000	50	49.4	23.5	59	25	261,200
MCR-630000	63	62.5	27.5	72	14	497,130

PP-R PLASTİK ÇİFT TARAFLI KAYNAKLI RAKOR PN 25

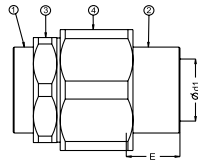

Kod	Ölçü (ø)	Ø d1	E	Miktar	Fiyat ₺
CKR-200000	20	19.5	14.5	100	18,970
CKR-250000	25	24.5	16	60	27,390
CKR-320000	32	31.5	18	50	37,920

PP-R PLASTİK ÇİFT TARAFLI KAYNAKLI RAKOR PN 16

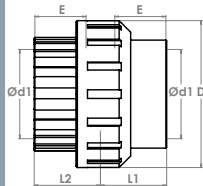

Kod	Ölçü (ø)	Ø d1	D	E	L1	L2	Miktar	Fiyat ₺
PKR-200000	20	19.5	43	14.5	21.5	24.3	200	15,170
PKR-250000	25	24.5	54	16	27.6	25.7	125	21,910
PKR-320000	32	31.5	60	18	25.2	30.1	100	30,340
PKR-400000	40	39.4	74	20.5	29	39	50	58,980
PKR-500000	50	49.4	92	23.5	34	45	30	84,260
PKR-630000	63	62.5	118	27.5	41	55	16	105,320
PKR-750000	75	74.2	130	31	47	53	10	330,320
PKR-900000	90	89.2	181	35.5	56	61	6	459,600
PKR-110000	110	109	210	41.5	65	71	3	603,240

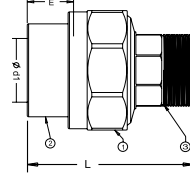

Kod	Ölçü (ø)	Ø d1	E	L	Miktar	Fiyat ₺
POE-200012	20 x 1/2"	19.5	14.5	60	100	17,250
POE-250034	25 x 3/4"	24.5	16	65	70	24,910
POE-320100	32 x 1"	31.5	18	67	50	34,460

PP-R PLASTİK OYNAR BAŞLI ERKEK RAKOR PN 25

Kod	Ölçü (ø)	Ø d1	E	L	Miktar	Fiyat ₺
POD-200012	20 x 1/2"	19.5	14.5	50	100	17,250
POD-250034	25 x 3/4"	24.5	16	55	80	24,910
POD-320100	32 x 1"	31.5	18	57	60	34,460

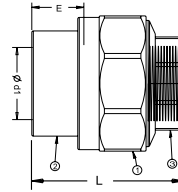
PP-R PLASTİK OYNAR BAŞLI DIŞI RAKOR PN 25

Kod	Kutu İçeriği	Miktar	Fiyat ₺
KHN-080000	PP-R Kombi Seti Hareketli Nipelli (8 Parça)	12	238,500
KHN-100000	PP-R Kombi Seti Hareketli Nipelli (10 Parça)	12	307,500
KHD-080000	PP-R Kombi Seti Hareketli Dirsekli (8 Parça)	12	238,500
KHD-100000	PP-R Kombi Seti Hareketli Dirsekli (10 Parça)	12	307,500

PP-R KOMBİ SETİ

Kod	Kutu İçeriği	Miktar	Fiyat ₺
EKN-080000	PP-R Kombi Seti Hareketli Nipelli (8 Parça)	12	216,000
EKN-100000	PP-R Kombi Seti Hareketli Nipelli (10 Parça)	12	264,000
EKD-080000	PP-R Kombi Seti Hareketli Dirsekli (8 Parça)	12	216,000
EKD-100000	PP-R Kombi Seti Hareketli Dirsekli (10 Parça)	12	264,000

PP-R KOMBİ SETİ (Ekonomik)



Yeşil **FORMÜL**
Yeşil **DOĞA**



formül[®]

**ISITMA GRUBU
ve VANALAR**

3

PE-RT BORU



Kod	Ölçü	Miktar	Fiyat ₺
PRT-160000	16 x 2 mm	160	8,900

KILIFLI PE-RT BORU



Kod	Ölçü	Miktar	Fiyat ₺
PRK-160000 Kırmızı	16 x 2 mm	100	13,500
PRK-160000 Mavi	16 x 2 mm	100	13,500

OKSİJEN BARIYERLİ PE-RT BORU



Kod	Ölçü	Miktar	Fiyat ₺
PRB-160000	16 x 2 mm	160	11,200

KILIFLI OKSİJEN BARIYERLİ PE-RT BORU



Kod	Ölçü	Miktar	Fiyat ₺
PBK-160000 Kırmızı	16 x 2 mm	100	15,850
PBK-160000 Mavi	16 x 2 mm	100	15,850

PP-R PE-X NİPELİ PN 25 - KUYRUKLU



Kod	Ölçü (ø)	Ø d1	E	L	Miktar	Fiyat ₺
SPK-201216	20x1/2x16	20.3	14.5	54	200	37,040

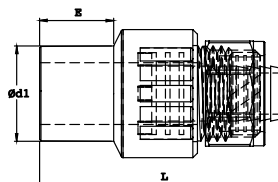

Kod	Ölçü (ø)	Ø d1	E	L	Miktar	Fiyat ₺
SPD-201216	20x1/2x16	19.5	14.5	54	200	37,040

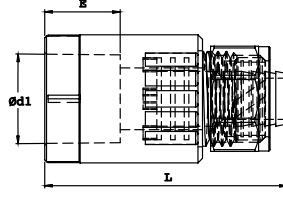

Kod	Ölçü	Miktar	Fiyat ₺
KRV-000012	1/2"	100	70,500

Kod	Ölçü	Miktar	Fiyat ₺
KRP-000012	1/2"	100	81,500

Kod	Ölçü	Miktar	Fiyat ₺
DRV-000012	1/2"	100	102,500

Kod	Ölçü	Miktar	Fiyat ₺
DRP-000012	1/2"	100	130,000

PP-R PE-X NİPELİ PN 25 - DIŞI**KÖŞE RADYATÖR VANASI****KÖŞE RADYATÖR VANASI PEX, PE-RT****DÜZ RADYATÖR VANASI****DÜZ RADYATÖR VANASI PE-RT**

KÜRESEL DOĞALGAZ VANASI



Kod	Ölçü	Miktar	Fiyat ₺
KDV-000012	1/2"	100	77,800
KDV-000034	3/4"	75	115,000
KDV-000100	1"	50	195,000
KDV-000114	1 1/4"	25	310,000
KDV-000112	1 1/2"	16	433,000
KDV-000200	2"	12	605,000

KÜRESEL VANA



Kod	Ölçü	Miktar	Fiyat ₺
KVP-010012	1/2"	125	70,500
KVP-010034	3/4"	100	102,500
KVP-010100	1"	60	163,000
KVP-010114	1 1/4"	40	267,000
KVP-010112	1 1/2"	24	385,000
KVP-010200	2"	15	533,000

KÜRESEL VANA KELEBEK KOLLU - RAKORLU



Kod	Ölçü	Miktar	Fiyat ₺
KKK-000100	1" Mavi	50	175,000
KKK-000100	1" Kırmızı	50	175,000

KALORİMETRE RAKORLU VANA

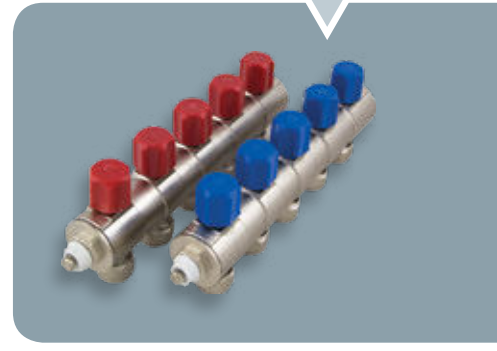

Kod	Ölçü	Miktar	Fiyat ₺
KLV-000100	1" Mavi	50	207,000
KLV-000100	1" Kırmızı	50	207,000

KENDİNDEN VANALI KOLLEKTÖR

Kod	Ölçü	Miktar	Fiyat ₺
VKL-020100	1" 2 Ağızlı	50	166,670
VKL-030100	1" 3 Ağızlı	36	250,620
VKL-040100	1" 4 Ağızlı	24	333,330
VKL-050100	1" 5 Ağızlı	20	416,670
VKL-060100	1" 6 Ağızlı	18	500,000
VKL-070100	1" 7 Ağızlı	16	582,720
VKL-080100	1" 8 Ağızlı	14	666,670
VKL-090100	1" 9 Ağızlı	12	750,000
VKL-100100	1" 10 Ağızlı	12	833,950
VKL-110100	1" 11 Ağızlı	12	916,670
VKL-120100	1" 12 Ağızlı	12	1.000,000
VKL-130100	1" 13 Ağızlı	10	1.083,330

PP-R KOLLEKTÖR VANASI PN 25

Kod	Ölçü (ø)	Ø d1	E	L	Miktar	Fiyat ₺
KTV-250100	25 x 1"	24.5	16	106	25	145,500
KTV-320100	32 x 1"	31.5	18	110	25	145,500

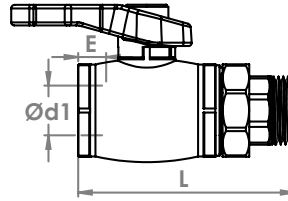

Kod	Ölçü	Miktar	Fiyat ₺
KLK-000100	1"	50	19,750

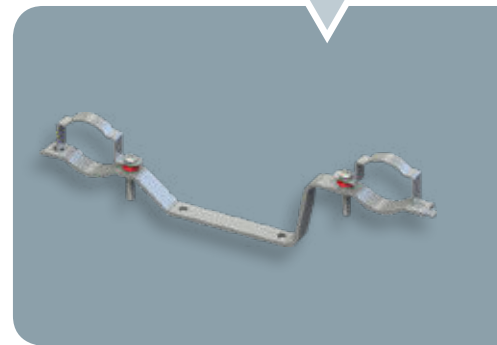
KOLLEKTÖR KELEPÇESİ

Çocuklarımıza **YAŞANABİLİR**
bir dünya bırakalım.





formül[®]

**AKSESUAR
GRUBU**

4

PP-R ATIK SU KELEPÇESİ

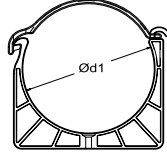
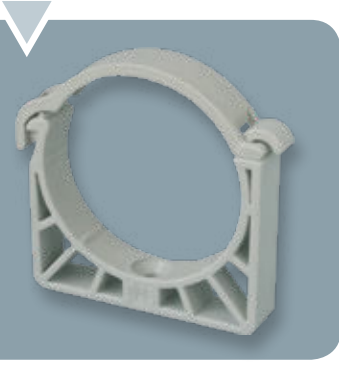

Kod	Ölçü (ø)	Ø d1	Miktar	Fiyat ₺
ATK-050000	50	50	250	2,500
ATK-075000	75	75	100	3,850
ATK-110000	110	110	130	6,500
ATK-125000	125	125	100	8,500
ATK-160000	160	160	75	13,500
ATK-200000	200	200	35	30,500

PP-R PLASTİK DERE KELEPÇESİ - PLASTİK ASKILI

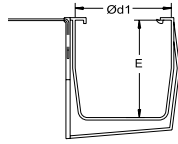
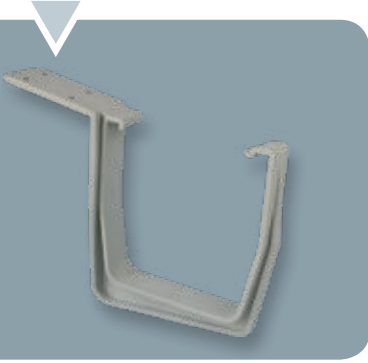

Kod	Ölçü (ø)	Ø d1	E	Miktar	Fiyat ₺
PDK-150000	150	150	150	75	8,410

PP-R PLASTİK DERE KELEPÇESİ-METAL ASKILI

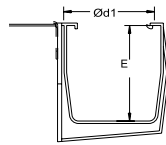

Kod	Ölçü (ø)	Ø d1	E	Miktar	Fiyat ₺
MDK-150000	150	150	150	75	18,520

PP-R DEK. PLASTİK DERE KELEPÇESİ - PLASTİK ASKILI

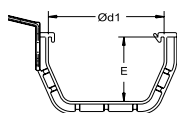
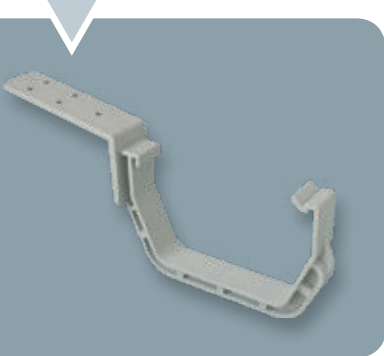

Kod	Ölçü (ø)	Ø d1	E	Miktar	Fiyat ₺
PDK-125000	125	125	75	100	6,570

PP-R DEK. PLASTİK DERE KELEPÇESİ METAL ASKILI

Kod	Ölçü (ø)	Ø d1	E	Miktar	Fiyat ₺
MDK-125000	125	125	75	100	18,520

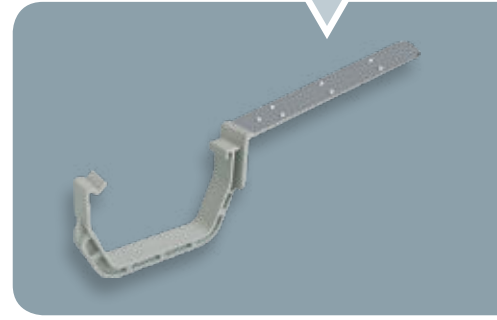
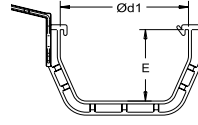

Kod	Ölçü (ø)	Ø d1	E	Miktar	Fiyat ₺
PIK-100000	100	100	75	100	5,200

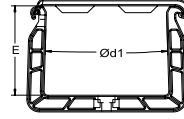
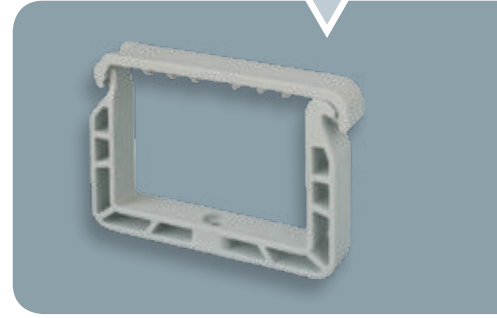
**PP-R PROFİL İNİŞ KELEPÇESİ**

Kod	Ölçü (ø)	Ø d1	L	Miktar	Fiyat ₺
TKP-200000	20	20	32	3000	0,560
TKP-250000	25	25	39	2750	0,710
TKP-320000	32	32	46	1800	1,050
TKP-400000	40	40	54	1400	1,210

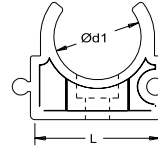
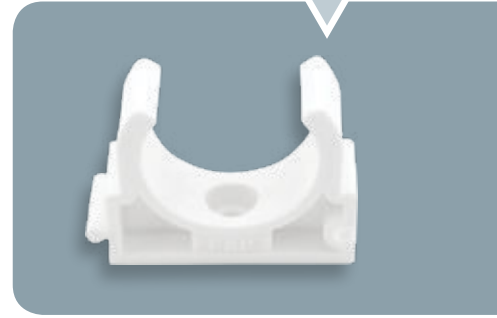
**PP-R TEKLİ KELEPÇE**

Kod	Ölçü (ø)	Ø d1	L	Miktar	Fiyat ₺
KPK-160000	16	16	28	2500	0,540
KPK-200000	20	20	32	2000	0,670
KPK-250000	25	25	37	2000	0,770
KPK-320000	32	32	44	1000	1,120
KPK-400000	40	40	52	750	1,620
KPK-500000	50	50	62	500	2,800

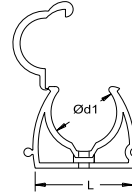
**PP-R KAPAKLI KELEPÇE**

Kod	Ölçü (ø)	Ø d1	Ø d2	E	Miktar	Fiyat ₺
DTK-200000	20	20	8	28	2000	0,770
DTK-250000	25	25	8	28	1500	0,850
DTK-320000	32	32	8	28	1000	1,130

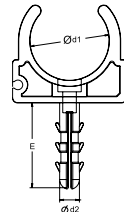
**PP-R DÜBELLİ TEKLİ KELEPÇE**

PP-R ÇİFTLİ KELEPÇE

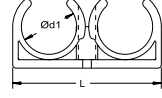

Kod	Ölçü (ø)	Ø d1	L	Miktar	Fiyat ₺
CKP-202200	20-22	20-22	60	1800	1,010
CKP-252700	25-27	25-27	65	1400	1,310
CKP-323400	32-34	32-34	72	750	1,740

PP-R DÜBELLİ ÇİFTLİ KELEPÇE

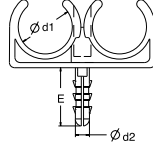

Kod	Ölçü (ø)	Ø d1	Ø d2	E	Miktar	Fiyat ₺
CDK-200000	20	20	8	28	2000	1,030
CDK-250000	25	25	8	28	1200	1,320
CDK-320000	32	32	8	28	750	2,070

PP-R DÜBELLİ ÇİFTLİ KROŞE

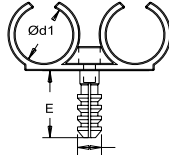

Kod	Ölçü (ø)	Ø d1	Ø d2	Ø d2	Miktar	Fiyat ₺
DCK-250000	25	25	8	28	1000	1,130

PP-R ÇİFTLİ KROŞE

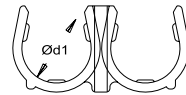

Kod	Ölçü (ø)	Ø d1	Miktar	Fiyat ₺
CTK-250000	25	22	2500	0,740

PP-R KÖŞE DÜZELTİCİ

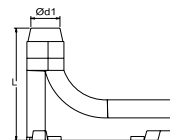

Kod	Ø d1	L	Miktar	Fiyat ₺
KDZ-180000	18	90	200	3,090

PP-R PLASTİK DÜBEL

Kod	Ölçü (ø)	Ø d1	L	Miktar	Fiyat ₺
PDB-060000	M6	6	30	30000	0,140
PDB-080000	M8	8	45	10000	0,170
PDB-100000	M10	10	60	5000	0,330

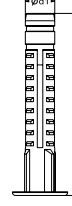

ROKET DÜBEL

Kod	Ölçü (ø)	Ø d1	L	Miktar	Fiyat ₺
RDB-080000	M8	8	51	10000	0,190
RDB-100000	M10	10	61	6000	0,310

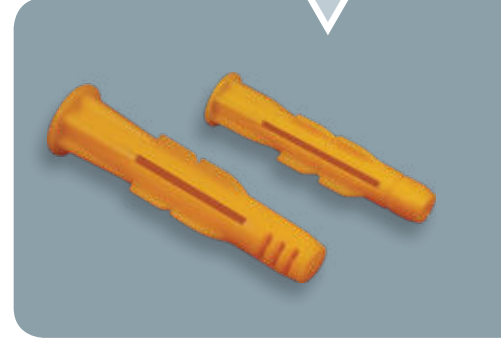
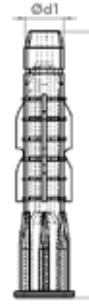

PP-R ÇİFTLİ YERE TESPİT DÜBELİ

Kod	Ölçü (ø)	Ø d1	L	Miktar	Fiyat ₺
YTC-250000	25	22	58	5000	0,250

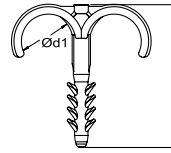

PP-R TEKLİ YERE TESPİT DÜBELİ

Kod	Ölçü (ø)	Ø d1	L	Miktar	Fiyat ₺
TYT-250000	25	22	56	8000	0,270

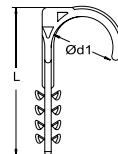

PP-R KLİPSLİ LAMA



Kod	Ø d1	L1	L2	Miktar	Fiyat ₺
KPL-160000	16	17.5	360	350	2,470

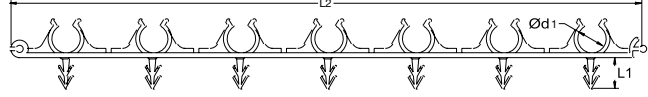

PP-R BORU TUTUCU

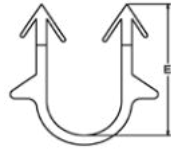

Kod	Ölçü (ø)	E	Miktar	Fiyat ₺
BRT-200000	20	36	8000	0,190

PP-R LAMA TUTUCU

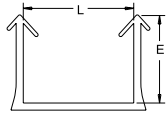

Kod	Ölçü (ø)	L	E	Miktar	Fiyat ₺
LMT-240000	24	24	24	8000	0,230

PP-R BORU GEÇİŞİ



Kod	Ölçü (ø)	Miktar	Fiyat ₺
BGS-000034	25 x 3/4"	175	5,350
BGS-000100	32 x 1"	140	7,200

Kod	Miktar	Fiyat ₺
BTP-161700	5000	0,250

PP-R BORU TAPASI

Kod	Miktar	Fiyat ₺
DMZ-000000	100	35,000

DOĞALGAZ MENFEZİ

Kod	Ölçü (ø)	Miktar	Fiyat ₺
EKK-110000	110	120 Adet / Çuval	24,800

KADA

Kod	Ölçü (ø)	Miktar	Fiyat ₺
ADC-050000	50	500 Adet / Çuval	2,350

ADAPTÖR CONTA

ROT

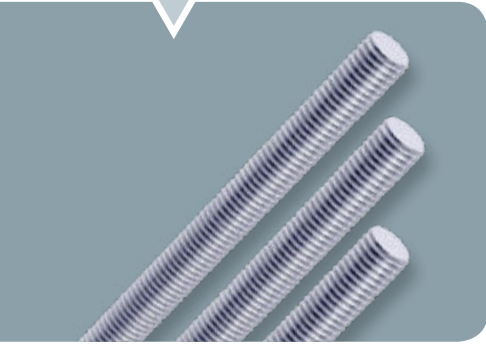

Kod	Ölçü (σ)	\varnothing d1	Miktar	Fiyat ₺
ROT-080000	M8	8	100	20,000
ROT-100000	M10	10	100	32,000
ROT-120000	M12	12	100	48,000

ÇAKMALI DÜBEL



Kod	Ölçü (σ)	Miktar	Fiyat ₺
CKD-080000	M8	100	6,100
CKD-100000	M10	100	9,500
CKD-120000	M12	100	17,500

ÇEKME Lİ DÜBEL

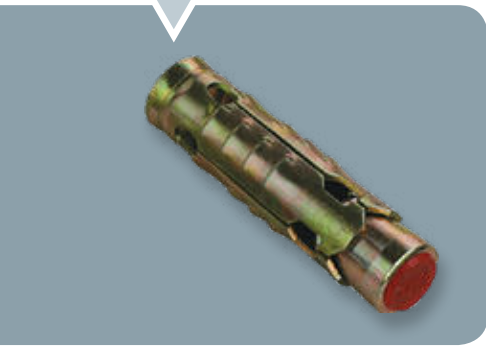

Kod	Ölçü (σ)	Miktar	Fiyat ₺
CMD-080000	M8	100	7,100
CMD-100000	M10	100	12,400
CMD-120000	M12	100	18,500

GÖMLEKLİ DÜBEL

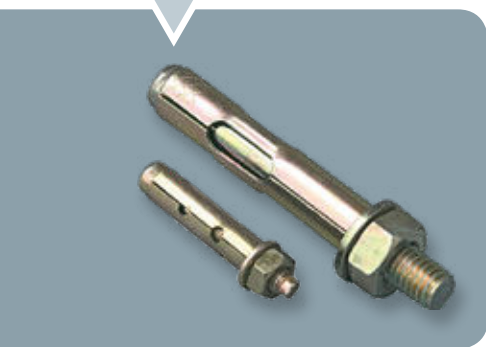

Kod	Ölçü (σ)	Miktar	Fiyat ₺
GMD-080000	M8	100	7,850
GMD-100000	M10	100	13,100
GMD-120000	M12	100	28,800

Kod	Ölçü (ø)	Ø d1	R	Miktar	Fiyat ₺
SMK-000038	3/8"	3/8	8 Rod	275	3,900
SMK-000012	1/2"	1/2	8 Rod	200	3,900
SMK-000034	3/4"	3/4	8 Rod	200	4,240
SMK-000100	1"	1	8 Rod	150	4,700
SMK-000114	1 1/4"	1 1/4	8 Rod	125	5,630
SMK-000112	1 1/2"	1 1/2	8 Rod	100	6,140
SMK-000200	2"	2	8 Rod	75	7,070
SMK-000212	2 1/2"	2 1/2	10 Rod	60	12,850
SMK-000300	3"	3	10 Rod	60	14,220
SMK-000312	3 1/2"	3 1/2	10 Rod	60	18,040
SMK-000400	4"	4	10 Rod	60	16,880
SMK-000412	4 1/2"	4 1/2	10 Rod	50	25,080
SMK-000500	5"	5	10 Rod	40	24,030
SMK-000512	5 1/2"	5 1/2	10 Rod	50	29,550
SMK-000600	6"	6	10 Rod	50	27,870
SMK-000800	8"	8	12 Rod	35	34,940
SMK-001000	10"	10	12 Rod	10	44,500

Kod	Ölçü (ø)	Ø d1	L	Miktar	Fiyat ₺
TSK-000038	3/8"	3/8	70	200	4,160
TSK-000012	1/2"	1/2	70	150	4,280
TSK-000034	3/4"	3/4	70	100	4,600
TSK-000100	1"	1	70	100	5,000
TSK-000114	1 1/4"	1 1/4	70	150	6,080
TSK-000112	1 1/2"	1 1/2	70	125	6,580
TSK-000200	2"	2	70	100	7,470
TSK-000212	2 1/2"	2 1/2	70	50	12,850
TSK-000300	3"	3	70	40	14,450
TSK-000312	3 1/2"	3 1/2	70	35	18,540
TSK-000400	4"	4	70	30	18,040
TSK-000412	4 1/2"	4 1/2	70	30	25,020
TSK-000500	5"	5	70	30	26,640

Kod	Ölçü (ø)	Ø d1	L	Miktar	Fiyat ₺
TUK-000038	3/8"	3/8	100	200	4,980
TUK-000012	1/2"	1/2	100	125	4,980
TUK-000034	3/4"	3/4	100	100	5,320
TUK-000100	1"	1	100	75	5,720
TUK-000114	1 1/4"	1 1/4	100	125	6,920
TUK-000112	1 1/2"	1 1/2	100	100	7,400
TUK-000200	2"	2	100	75	8,570
TUK-000212	2 1/2"	2 1/2	100	50	13,630
TUK-000300	3"	3	100	40	18,610
TUK-000312	3 1/2"	3 1/2	100	35	20,310
TUK-000400	4"	4	100	30	20,440
TUK-000412	4 1/2"	4 1/2	100	30	29,070
TUK-000500	5"	5	100	25	27,820

SOMUNLU KELEPÇE

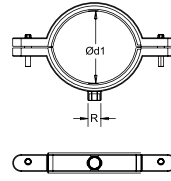

TRİFONLU STANDART KELEPÇE

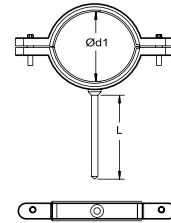
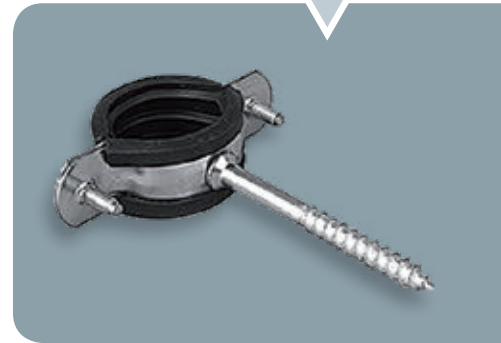

TRİFONLU UZUN KELEPÇE

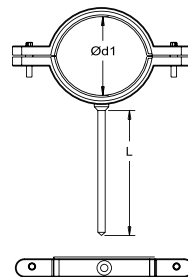

BORU MAKASI



Kod	GM	Fiyat ₺
DBM-001242	GM 0012-42	257,780
DBM-002863	GM 0028-63	1.244,440
DBM-002775	GM 0027-75	1.548,150

KAYNAK MAKİNESİ SETİ



Kod	Set	Fiyat ₺
KMS-000500	Cobra Kaynak Makinesi Set	1.503,700
KMS-0008A0	Ekonomik Kaynak Makinesi Set	1.200,000
KMS-002100	Yuvarlak Kaynak Makinesi Set	1.822,220

KAYNAK MAKİNESİ



Kod	Makine	Fiyat ₺
LKM-0009A0	Cobra Kaynak Makinesi	1.022,220
SKM-000900	Ekonomik Kaynak Makinesi	933,330
PKM-0009B0	Yuvarlak Kaynak Makinesi	1.333,330

TEST POMPASI

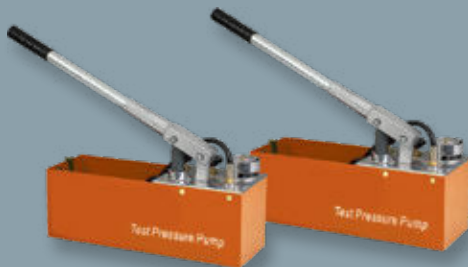

Kod	GM	Fiyat ₺
TSP-003000	GM 0030	2.985,190

Kod	Ölçü (ø)	Fiyat ₺
BTA-202500	20 x 25	265,930
BTA-324000	32 x 40	322,960
BTA-506300	50 x 63	444,440

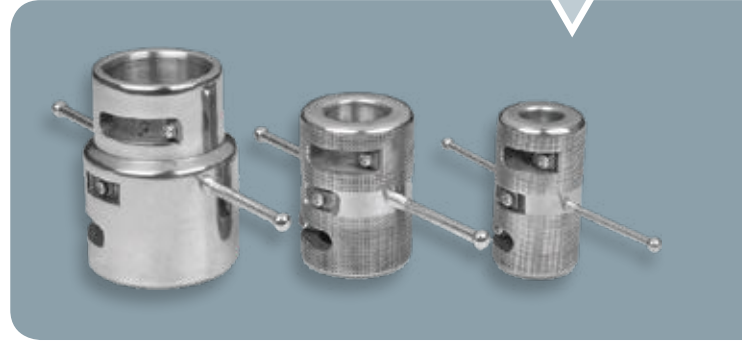
BORU TRAŞLAMA

Kod	Ölçü (ø)	Fiyat ₺
BKP-200000	20	86,670
BKP-250000	25	97,330
BKP-320000	32	104,000
BKP-400000	40	134,960
BKP-500000	50	230,370
BKP-630000	63	268,150
BKP-750000	75	321,480
BKP-900000	90	533,330
BKP-110000	110	705,930
BKP-125000	125	838,520

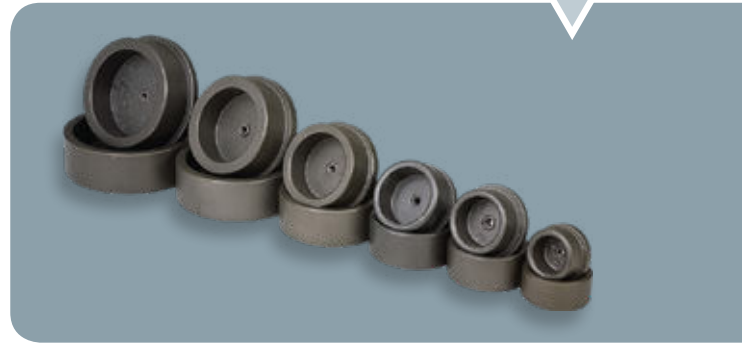
KAYNAK PAFTASI

Kod	Ölçü (ø)	Fiyat ₺
BKP-632000	63/20	343,700
BKP-632500	63/25	343,700
BKP-633200	63/32	343,700
BKP-752000	75/20	370,370
BKP-752500	75/25	370,370
BKP-753200	75/32	370,370
BKP-902000	90/20	407,410
BKP-902500	90/25	407,410
BKP-903200	90/32	407,410
BKP-112000	110/20	429,630
BKP-112500	110/25	429,630
BKP-113200	110/32	429,630

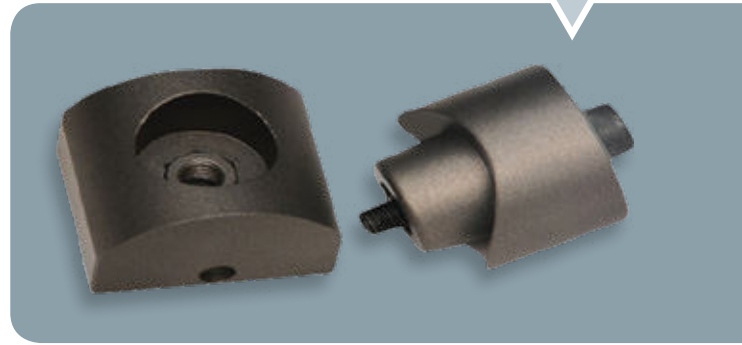
BRANŞMAN KAYNAK PAFTASI

Kod	Fiyat ₺
BKA-000000	222,220

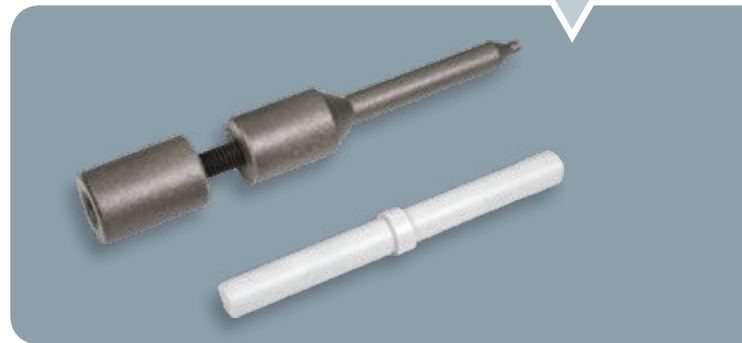
TAMİR APARATI



Hayatın
bir **FORMÜL**'ü var



formül[®]

**PVC BORU ve
EK PARÇALARI**

5

PVC ATIK SU BORUSU - TİP 1



Kod	Ölçü	Miktar	Fiyat ₺
TP1-050015	50/150	100 Adet /Çuval	8,570
TP1-050025	50/250	80 Adet /Çuval	12,140
TP1-050050	50/500	40 Adet/Çuval	18,950
TP1-050100	50/1000	10 Adet/Bağ	31,680
TP1-050200	50/2000	10 Adet/Bağ	61,750
TP1-050300	50/3000	10 Adet/Bağ	91,960
TP1-050600	50/6000	1 Adet	178,630
TP1-075015	75/150	60 Adet /Çuval	14,810
TP1-075025	75/250	40 Adet /Çuval	21,420
TP1-075050	75/500	20 Adet/Çuval	30,490
TP1-075100	75/1000	5 Adet/Bağ	53,630
TP1-075200	75/2000	5 Adet/Bağ	103,920
TP1-075300	75/3000	5 Adet/Bağ	153,350
TP1-075600	75/6000	1 Adet	300,910
TP1-110015	110/150	30 Adet /Çuval	22,430
TP1-110025	110/250	20 Adet /Çuval	31,370
TP1-110050	110/500	10 Adet/Çuval	47,840
TP1-110100	110/1000	5 Adet/Bağ	81,420
TP1-110200	110/2000	5 Adet/Bağ	158,700
TP1-110300	110/3000	4 Adet/Bağ	227,530
TP1-110600	110/6000	1 Adet	451,110
TP1-125015	125/150	24 Adet /Çuval	29,470
TP1-125025	125/250	16 Adet /Çuval	41,490
TP1-125050	125/500	10 Adet /Bağ	61,250
TP1-125100	125/1000	5 Adet /Bağ	105,120
TP1-125200	125/2000	5 Adet /Bağ	203,010
TP1-125300	125/3000	3 Adet /Bağ	300,620
TP1-125600	125/6000	1 Adet	597,630
TP1-160015	160/150	15 Adet /Bağ	44,430
TP1-160025	160/250	12 Adet /Bağ	60,870
TP1-160050	160/500	6 Adet /Bağ	104,440
TP1-160100	160/1000	3 Adet /Bağ	176,950
TP1-160200	160/2000	3 Adet /Bağ	338,520
TP1-160300	160/3000	1 Adet /Bağ	497,890
TP1-160600	160/6000	1 Adet	968,390
TP1-200015	200/150	9 Adet /Bağ	73,510
TP1-200025	200/250	9 Adet /Bağ	98,510
TP1-200050	200/500	6 Adet /Bağ	165,180
TP1-200100	200/1000	3 Adet	290,130
TP1-200200	200/2000	1 Adet	554,230
TP1-200300	200/3000	1 Adet	810,190
TP1-200600	200/6000	1 Adet	1.569,810

PVC ATIK SU BORUSU - TİP 2



Kod	Ölçü	Miktar	Fiyat ₺
TP2-050050	50/500	40 Adet/Çuval	12,490
TP2-050100	50/1000	10 Adet/Bağ	22,080
TP2-050200	50/2000	10 Adet/Bağ	42,780
TP2-050300	50/3000	10 Adet/Bağ	63,680
TP2-050600	50/6000	1 Adet	124,790
TP2-075050	75/500	20 Adet/Çuval	20,160
TP2-075100	75/1000	5 Adet/Bağ	36,470
TP2-075200	75/2000	5 Adet/Bağ	70,430
TP2-075300	75/3000	5 Adet/Bağ	104,200
TP2-075600	75/6000	1 Adet	203,470
TP2-110050	110/500	10 Adet/Çuval	33,300
TP2-110100	110/1000	5 Adet/Bağ	57,980
TP2-110200	110/2000	5 Adet/Bağ	112,390
TP2-110300	110/3000	5 Adet/Bağ	166,120
TP2-110600	110/6000	1 Adet	320,070
TP2-125050	125/500	10 Adet /Bağ	45,760
TP2-125100	125/1000	5 Adet /Bağ	82,030
TP2-125200	125/2000	5 Adet /Bağ	156,530
TP2-125300	125/3000	3 Adet /Bağ	230,940
TP2-125600	125/6000	1 Adet	451,200
TP2-160050	160/500	6 Adet /Bağ	81,920
TP2-160100	160/1000	3 Adet /Bağ	144,900
TP2-160200	160/2000	3 Adet /Bağ	277,530
TP2-160300	160/3000	3 Adet /Bağ	408,020
TP2-160600	160/6000	1 Adet	814,090
TP2-200050	200/500	6 Adet /Bağ	133,440
TP2-200100	200/1000	3 Adet	232,430
TP2-200200	200/2000	1 Adet	436,670
TP2-200300	200/3000	1 Adet	632,240
TP2-200600	200/6000	1 Adet	1.243,050

Kod	Ölçü	Miktar	Fiyat ₺
DRS-050045	50	250 Adet/Çuval	6,340
DRS-075045	75	100 Adet/Çuval	11,170
DRS-110045	110	35 Adet/Çuval	22,100
DRS-125045	125	25 Adet/Çuval	32,360
DRS-160045	160	15 Adet/Çuval	62,540
DRS-200045	200	8 Adet/Çuval	158,020



Kod	Ölçü	Miktar	Fiyat ₺
DRS-050087	50	200 Adet/Çuval	7,500
DRS-075087	75	75 Adet/Çuval	14,520
DRS-110087	110	30 Adet/Çuval	27,850
DRS-125087	125	20 Adet/Çuval	40,720
DRS-160087	160	12 Adet/Çuval	82,410
DRS-200087	200	6 Adet/Çuval	214,450



Kod	Ölçü	Miktar	Fiyat ₺
TEC-050050	50x50	125 Adet/Çuval	13,690
TEC-075050	75x50	70 Adet/Çuval	20,600
TEC-075075	75x75	50 Adet/Çuval	26,100
TEC-110050	110x50	30 Adet/Çuval	30,470
TEC-110075	110x75	25 Adet/Çuval	42,800
TEC-110110	110x110	20 Adet/Çuval	46,550
TEC-160110	160x110	10 Adet/Bağ	122,320
TEC-160160	160x160	8 Adet/Bağ	176,860



Kod	Ölçü	Miktar	Fiyat ₺
TKC-050050	50x50	100 Adet/Çuval	12,850
TKC-075050	75x50	50 Adet/Çuval	19,320
TKC-075075	75x75	40 Adet/Çuval	29,100
TKC-110050	110x50	25 Adet/Çuval	30,760
TKC-110075	110x75	20 Adet/Çuval	43,310
TKC-110110	110x110	15 Adet/Çuval	53,690
TKC-125110	125x110	10 Adet/Bağ	78,660
TKC-125125	125x125	10 Adet/Bağ	95,310
TKC-160110	160x110	5 Adet/Bağ	134,820
TKC-160160	160x160	4 Adet/Bağ	206,870



ÇİFT ÇATAL 45°



Kod	Ölçü	Miktar	Fiyat ₺
YCC-050050	50x50	60 Adet/Çuval	24,010
YCC-075050	75x50	40 Adet/Çuval	34,170
YCC-075075	75x75	25 Adet/Çuval	54,410
YCC-110050	110x50	25 Adet/Çuval	52,240
YCC-110075	110x75	20 Adet/Çuval	80,170
YCC-110110	110x110	10 Adet/Bağ	82,930

İSTAVROZ TE 87°



Kod	Ölçü	Miktar	Fiyat ₺
TCC-050050	50x50	75 Adet/Çuval	20,750
TCC-110110	110x110	10 Adet/Bağ	71,480

KAYAR MANŞON



Kod	Ölçü	Miktar	Fiyat ₺
KMN-050000	50	200 Adet/Çuval	9,200
KMN-075000	75	100 Adet/Çuval	14,680
KMN-110000	110	40 Adet/Çuval	26,200
KMN-125000	125	25 Adet/Çuval	45,210
KMN-160000	160	12 Adet/Çuval	81,970

REDÜKSİYON



Kod	Ölçü	Miktar	Fiyat ₺
RDK-075050	75x50	150 Adet/Çuval	10,010
RDK-110050	110x50	70 Adet/Çuval	16,100
RDK-110075	110x75	50 Adet/Çuval	16,910
RDK-125075	125x75	50 Adet/Çuval	31,400
RDK-125110	125x110	30 Adet/Çuval	31,940
RDK-160110	160x110	25 Adet/Çuval	58,290

TEMİZLEME TE

Kod	Ölçü	Miktar	Fiyat ₺
TMT-050000	50	100 Adet/Çuval	26,500
TMT-075000	75	50 Adet/Çuval	30,380
TMT-110000	110	20 Adet/Çuval	58,750
TMT-125000	125	10 Adet/Bağ	106,520

**MUF TAPASI**

Kod	Ölçü	Miktar	Fiyat ₺
KPM-050000	50	900 Adet/Çuval	4,820
KPM-075000	75	400 Adet/Çuval	8,740
KPM-110000	110	150 Adet/Çuval	11,920
KPM-125000	125	125 Adet/Çuval	19,800
KPM-160000	160	75 Adet/Çuval	40,390
KPM-200000	200	50 Adet/Çuval	86,720

**S SİFON**

Kod	Ölçü	Miktar	Fiyat ₺
SFN-110087	110x87°	10 Adet/Çuval	75,380
SFN-110045	110x45°	10 Adet/Çuval	70,200

**KADA**

Kod	Ölçü	Miktar	Fiyat ₺
EKK-110000	110	120 Adet / Çuval	24,800



ADAPTÖR CONTA



Kod	Ölçü	Miktar	Fiyat ₺
ADC-050000	50	500 Adet / Çuval	2,350

ATIK SU KELEPÇESİ



Kod	Ölçü	Miktar	Fiyat ₺
ATK-050000	50 mm	250 Adet/Koli	2,500
ATK-075000	75 mm	100 Adet/Koli	3,850
ATK-110000	110 mm	130 Adet/Koli	6,500
ATK-125000	125 mm	100 Adet/Koli	8,500
ATK-160000	160 mm	75 Adet/Koli	13,500
ATK-200000	200 mm	35 Adet/Koli	30,500

KİLİTLİ ÇEKVALF



Kod	Ölçü	Miktar	Fiyat ₺
KLC-110000	110	12	285,000
KLC-125000	125	12	360,000
KLC-160000	160	8	510,000
KLC-200000	200	4	1.010,000



yerli üretim

stoktan hızlı teslim

zengin ürün yelpazesi

Çevre Politikamız

Firmamız, çevre yönetim sistemimizi sürekli iyileştirecek hedefler belirlemeyi, bu hedefleri yapacağı toplantılarda gözden geçirmeyi, çalışanlara sağlıklı, güvenli ve temiz bir iş ortamı sunmayı amaçlamaktadır.

Bu yüzden politikamız;

- İlgili çevre ve enerji mevzuatı gereklerini karşılamak ve hatta aşmak,
- Çevre ve enerji yönetim sistemlerini sürekli geliştirmek için çalışmak,
- Atıkları minimuma indirmek, kirliliği kaynağında önlemek, enerjiyi verimli kullanmak ve faaliyetlerimizin çevre üzerindeki olumsuz etkilerini azaltmak,
- Çevreyi korumak ve bu prensibi tüm çevremize, ülkeye ve dünyaya yaymak,
- Çevre ile ilgili acil durumlar için riskleri belirlemek ve bunları azaltmak,
- Çalışanlara ve bayilerimize, çevre bilinci ve enerjinin verimli kullanımı ile ilgili bilinçlendirme eğitimleri vererek onları geliştirmek,
- Çevreye olan etkilerimizin azaltılması ve enerjinin verimli kullanılması için gerekli insan kaynağı, teknoloji ve finansal kaynakları sağlamaktır.



Fabrikamızda üretim yaparken ortaya çıkan enerjiyi, ısıtma ve soğutma sistemlerinde kullanarak enerji tasarrufunda da üzerimize düşeni yapmaktayız.

formül[®]



formül[®]
PP-R, PVC BORU ve EK PARÇALARI

Dünya Çapında

30
YILLIK
KALİTE
HİKAYESİ

50
YIL
GARANTİ

formul.com.tr

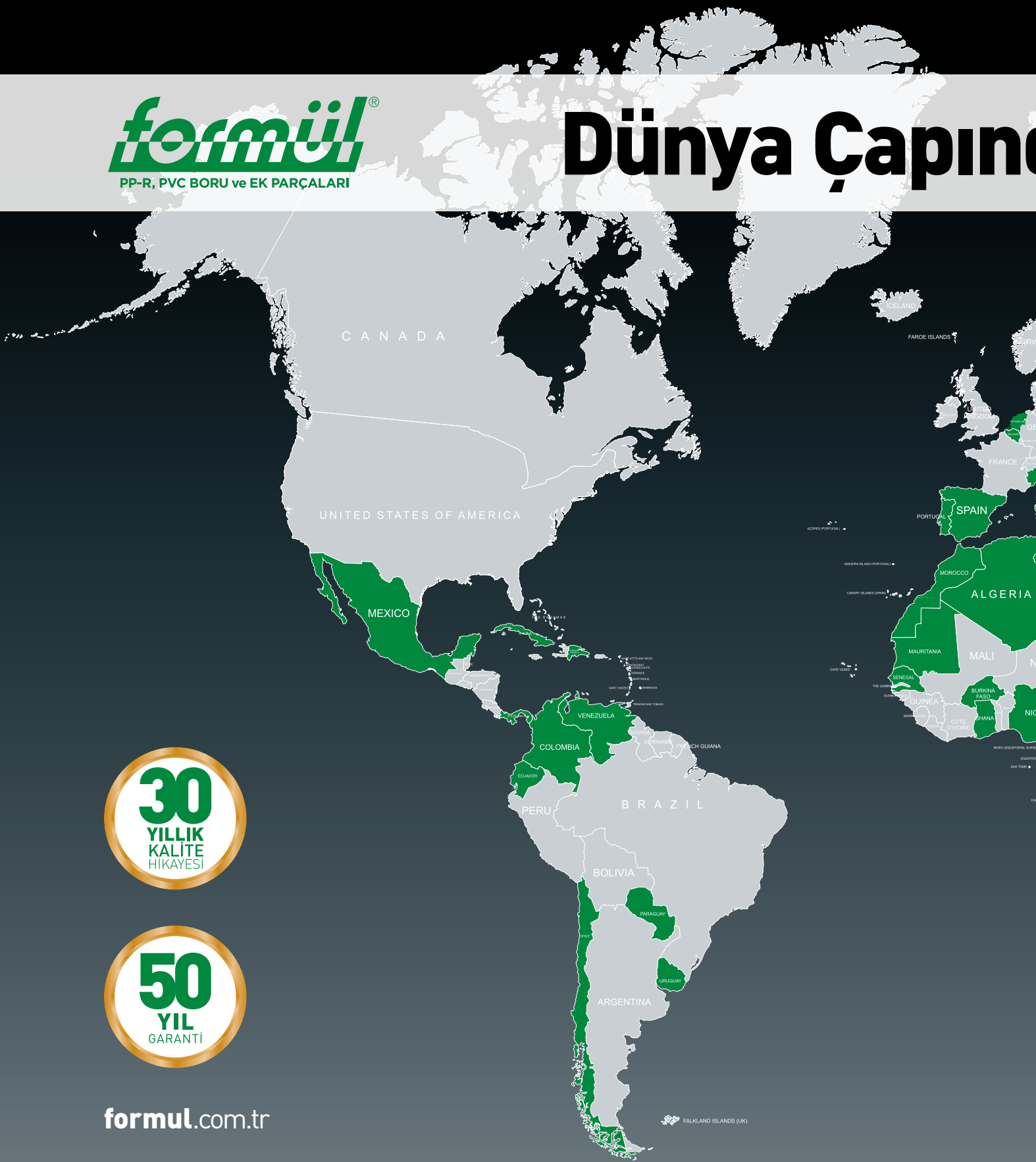



Dünya'nın Tercih, Türkiye'nin Markası

Bayi:



www.formul.com.tr
satis@formul.com.tr
satis-destek@formul.com.tr
satis-operasyon@formul.com.tr



Merkez Ofis:

Cumhuriyet Mah. Gürpınar Yolu Cad.
Kaya Milenyum İş Merkezi Kat:8
No:5A/144 Beykent-**Büyükçekmece / İstanbul**

T: +90 212 876 12 60
F: +90 212 876 12 59



Plastik Fabrika:

Veliköy OSB Mah. Sanayi Bulvarı No. 19/4 A
Veliköy - **Çerkezköy / Tekirdağ**

T: +90 282 746 15 60
F: +90 282 746 15 59



Metal ve PVC Fabrika:

Gazi Osman Paşa OSB Mah. 1. Cad.
Selvi Örne Sit. Fabrika Binası
No:135/B **Çerkezköy / Tekirdağ**

T: +90 282 758 25 06
F: +90 282 758 25 05

04.2021

